

Thyristor/Diode Modules M## 500

Absolute Maximum Ratings

V_{RRM} V_{DRM} [V]							
	MCC	MCD	MDC	MCA	MCK	MCDA	MDCA
1200	500-12io1	500-12io1	500-12io1	500-12io1	500-12io1	500-12io1	500-12io1
1400	500-14io1	500-14io1	500-14io1	500-14io1	500-14io1	500-14io1	500-14io1
1600	500-16io1	500-16io1	500-16io1	500-16io1	500-16io1	500-16io1	500-16io1
1800	500-18io1	500-18io1	500-18io1	500-18io1	500-18io1	500-18io1	500-18io1

	VOLTAGE RATINGS	MAXIMUM LIMITS	UNITS
V_{DRM}	Repetitive peak off-state voltage ¹⁾	1200-1800	V
V_{DSM}	Non-repetitive peak off-state voltage ¹⁾	1200-1800	V
V_{RRM}	Repetitive peak reverse voltage ¹⁾	1200-1800	V
V_{RSM}	Non-repetitive peak reverse voltage ¹⁾	1300-1900	V

	OTHER RATINGS	MAXIMUM LIMITS	UNITS
$I_{T(AV)M}$	Maximum average on-state current, $T_C = 89^\circ\text{C}$ ²⁾	500	A
$I_{T(AV)M}$	Maximum average on-state current. $T_C = 85^\circ\text{C}$ ²⁾	545	A
$I_{T(AV)M}$	Maximum average on-state current. $T_C = 100^\circ\text{C}$ ²⁾	376	A
$I_{T(RMS)M}$	Nominal RMS on-state current, $T_C = 55^\circ\text{C}$ ²⁾	1294	A
$I_{T(d.c.)}$	D.C. on-state current, $T_C = 55^\circ\text{C}$	1029	A
I_{TSM}	Peak non-repetitive surge $t_p = 10$ ms, $V_{RM} = 60\%V_{RRM}$ ³⁾	16.5	kA
I_{TSM2}	Peak non-repetitive surge $t_p = 10$ ms, $V_{RM} \leq 10\text{V}$ ³⁾	18.2	kA
I^2t	I^2t capacity for fusing $t_p = 10$ ms, $V_{RM} = 60\%V_{RRM}$ ³⁾	1.36×10^6	A^2s
I^2t	I^2t capacity for fusing $t_p = 10$ ms, $V_{RM} \leq 10\text{V}$ ³⁾	1.66×10^6	A^2s
$(di/dt)_{cr}$	Critical rate of rise of on-state current (repetitive) ⁴⁾	150	$\text{A}/\mu\text{s}$
	Critical rate of rise of on-state current (non-repetitive) ⁴⁾	300	$\text{A}/\mu\text{s}$
V_{RGM}	Peak reverse gate voltage	5	V
$P_{G(AV)}$	Mean forward gate power	4	W
P_{GM}	Peak forward gate power	30	W
V_{ISOL}	Isolation Voltage ⁵⁾	3500	V
$T_{vj\text{ op}}$	Operating temperature range	-40 to +125	$^\circ\text{C}$
T_{stg}	Storage temperature range	-40 to +150	$^\circ\text{C}$

Notes:

- De-rating factor of 0.13% per $^\circ\text{C}$ is applicable for T_{vj} below 25°C .
- Single phase; 50 Hz, 180° half-sinewave.
- Half-sinewave, 125°C T_{vj} initial.
- $V_D = 67\% V_{DRM}$, $I_{FG} = 2$ A, $t_r \leq 0.5\mu\text{s}$, $T_C = 125^\circ\text{C}$.
- AC RMS voltage, 50 Hz, 1min test

Thyristor Characteristics

	PARAMETER	MIN.	TYP.	MAX.	TEST CONDITIONS ¹⁾	UNITS
V _{TM}	Maximum peak on-state voltage	-	-	1.5	I _{TM} = 1700 A	V
V _{TM}	Maximum peak on-state voltage	-	-	1.43	I _{TM} = 1500 A	V
V _{T0}	Threshold voltage	-	-	0.85		V
r _T	Slope resistance	-	-	0.27		mΩ
(dv/dt) _{cr}	Critical rate of rise of off-state voltage	1000	-	-	V _D = 80% V _{DRM} , linear ramp, Gate o/c	V/μs
I _{DRM}	Peak off-state current	-	-	70	Rated V _{DRM}	mA
I _{RDM}	Peak reverse current	-	-	70	Rated V _{RDM}	mA
V _{GT}	Gate trigger voltage	-	-	3.0	T _{vj} = 25°C, V _D = 10 V, I _T = 3 A	V
I _{GT}	Gate trigger current	-	-	300		mA
I _H	Holding current	-	-	1000	T _{vj} = 25°C	mA
t _{gd}	Gate controlled turn-on delay time	-	0.6	1.5	I _{FG} = 2 A, t _r = 0.5 μs, V _D = 67%V _{DRM} , I _{TM} = 2000 A, di/dt = 10 A/μs, T _{vj} = 25°C	μs
t _{gt}	Turn-on time	-	1.2	2.5		μs
Q _{rr}	Recovered Charge	-	2200	-		μC
Q _{ra}	Recovered Charge, 50% chord	-	1600	1900	I _{TM} = 1000 A, t _p = 1 ms, di/dt = 10A/μs, V _R = 50 V	μC
I _{rm}	Reverse recovery current	-	120	-		A
t _{rr}	Reverse recovery time, 50% chord	-	25	-		μs
t _q	Turn-off time	-	200	-	I _{TM} = 1000 A, t _p = 1 ms, di/dt = 10 A/μs, V _R = 50 V, V _{DR} = 80%V _{DRM} , dv _{DR} /dt = 20 V/μs	μs
		-	300	-	I _{TM} = 1000 A, t _p = 1 ms, di/dt = 10 A/μs, V _R = 50 V, V _{DR} = 80%V _{DRM} , dv _{DR} /dt = 200 V/μs	
R _{thJC}	Thermal resistance, junction to case	-	-	0.062	Single Thyristor	K/W
		-	-	0.031	Whole Module	K/W
R _{thCH}	Thermal resistance, case to heatsink	-	-	0.02	Single Thyristor	K/W
		-	-	0.01	Whole Module	K/W
F ₁	Mounting force (to heatsink)	4.25	-	5.75		Nm
F ₂	Mounting force (to terminals)	10.2	-	13.8	²⁾	Nm
W _t	Weight	-	1.5	-		kg

Diode Characteristics

	PARAMETER	MIN.	TYP.	MAX.	TEST CONDITIONS ¹⁾	UNITS
V _{FM}	Maximum peak forward voltage	-	-	0.98	I _{TM} = 1800 A	V
V _{T0}	Threshold voltage	-	-	0.72		V
r _T	Slope resistance	-	-	0.143		mΩ
I _{RDM}	Peak reverse current	-	-	50	Rated V _{RDM}	mA
Q _{rr}	Recovered Charge	-	2200	-		μC
Q _{ra}	Recovered Charge, 50% chord	-	1800	2250	I _{TM} = 1000 A, t _p = 1 ms, di/dt = 10 A/μs, V _R = 50 V	μC
I _{RM}	Reverse recovery current	-	145	-		A
t _{rr}	Reverse recovery time, 50% chord	-	25	-		μs

Notes:

- 1) Unless otherwise indicated T_{vj}=125°C.
- 2) Screws must be lubricated

Notes on Ratings and Characteristics

1.0 Voltage Grade Table

Voltage Grade	V_{DRM} V_{DSM} V_{RRM} V	V_{RSM} V	V_D V_R DC V
12	1200	1300	820
14	1400	1500	930
16	1600	1700	1040
18	1800	1900	1150

2.0 Extension of Voltage Grades

This report is applicable to other voltage grades when supply has been agreed by Sales/Production.

3.0 De-rating Factor

A blocking voltage de-rating factor of 0.13%/°C is applicable to this device for T_{vj} below 25°C.

4.0 Repetitive dv/dt

Standard dv/dt is 1000V/μs.

5.0 Snubber Components

When selecting snubber components, care must be taken not to use excessively large values of snubber capacitor or excessively small values of snubber resistor. Such excessive component values may lead to device damage due to the large resultant values of snubber discharge current. If required, please consult the factory for assistance.

6.0 Rate of rise of on-state current

The maximum un-primed rate of rise of on-state current must not exceed 300A/μs at any time during turn-on on a non-repetitive basis. For repetitive performance, the on-state rate of rise of current must not exceed 150A/μs at any time during turn-on. Note that these values of rate of rise of current apply to the total device current including that from any local snubber network.

7.0 Gate Drive

The nominal requirement for a typical gate drive is illustrated below. An open circuit voltage of at least 30V is assumed. This gate drive must be applied when using the full di/dt capability of the device.

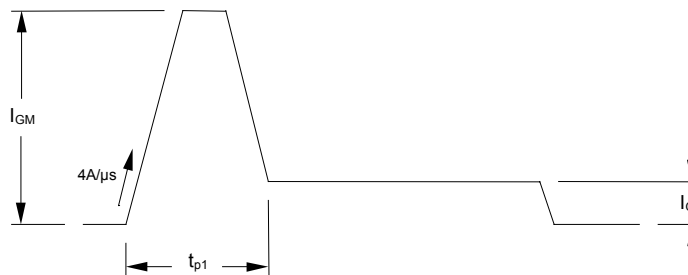

The magnitude of I_{GM} should be between five and ten times I_{GT} , which is shown on page 2. Its duration (t_{p1}) should be 20μs or sufficient to allow the anode current to reach ten times I_L , whichever is greater. Otherwise, an increase in pulse current could be needed to supply the necessary charge to trigger. The 'back-porch' current I_G should remain flowing for the same duration as the anode current and have a magnitude in the order of 1.5 times I_{GT} .

8.0 Computer Modelling Parameters

8.1 Thyristor Dissipation Calculations

$$I_{AV} = \frac{-V_{T0} + \sqrt{V_{T0}^2 + 4 \cdot ff^2 \cdot r_T \cdot W_{AV}}}{2 \cdot ff^2 \cdot r_T} \quad \text{and:} \quad W_{AV} = \frac{\Delta T}{R_{th}}$$

$$\Delta T = T_{j\max} - T_K$$

Where $V_{T0} = 0.85 \text{ V}$, $r_T = 0.27 \text{ m}\Omega$ for the thyristor and $V_{T0} = 0.72 \text{ V}$, $r_T = 0.143 \text{ m}\Omega$ for the diode.

R_{th} = Supplementary thermal impedance, see table below and

ff = Form factor, see table below.

Supplementary Thermal Impedance							
Conduction Angle	30°	60°	90°	120°	180°	270°	d.c.
Square wave	0.07067	0.06791	0.06629	0.06525	0.06395	0.06277	0.062
Sine wave	0.06767	0.06536	0.06408	0.0633	0.062		

Form Factors							
Conduction Angle	30°	60°	90°	120°	180°	270°	d.c.
Square wave	3.464	2.449	2	1.732	1.414	1.149	1
Sine wave	3.98	2.778	2.22	1.879	1.57		

8.2 Calculating thyristor V_T using ABCD Coefficients

The on-state characteristic I_T vs. V_T , on page 6 is represented in two ways;

- the well established V_{T0} and r_T tangent used for rating purposes and
- a set of constants A, B, C, D, forming the coefficients of the representative equation for V_T in terms of I_T given below:

$$V_T = A + B \cdot \ln(I_T) + C \cdot I_T + D \cdot \sqrt{I_T}$$

The constants, derived by curve fitting software, are given below for both hot and cold characteristics. The resulting values for V_T agree with the true device characteristic over a current range, which is limited to that plotted.

25°C Coefficients		125°C Coefficients	
A	0.7860338	A	-0.099137717
B	9.929062×10^{-3}	B	0.1987038
C	1.94704×10^{-4}	C	4.23812×10^{-4}
D	7.409213×10^{-3}	D	-0.01453705

8.3 D.C. Thermal Impedance Calculation

$$r_t = \sum_{p=1}^{p=n} r_p \cdot \left(1 - e^{-\frac{t}{\tau_p}} \right)$$

Where $p = 1$ to n

- n = number of terms in the series and
 t = Duration of heating pulse in seconds.
 r_t = Thermal resistance at time t .
 r_p = Amplitude of p_{th} term.
 τ_p = Time Constant of r_{th} term).

The coefficients for this device are shown in the tables below:

D.C.				
Term	1	2	3	4
r_p	0.05428	4.4894×10^{-3}	2.3382×10^{-3}	8.759×10^{-4}
τ_p	2.69428	0.126017	0.013878	1.435×10^{-3}

9.0 Reverse recovery ratings

- (i) Q_{rr} is based on 50% I_{RM} chord as shown in Fig. 1

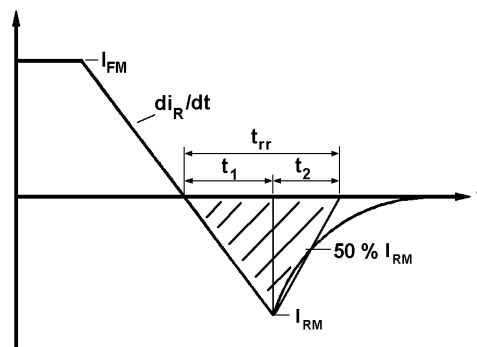

Fig. 1

- (ii) Q_{rr} is based on a 150 μs integration time i.e.

$$Q_{rr} = \int_0^{150 \mu s} i_{rr} \cdot dt$$

- (iii)

$$K \text{ Factor} = \frac{t_1}{t_2}$$

Thyristor Curves

Figure 1 - On-state characteristics of Limit device

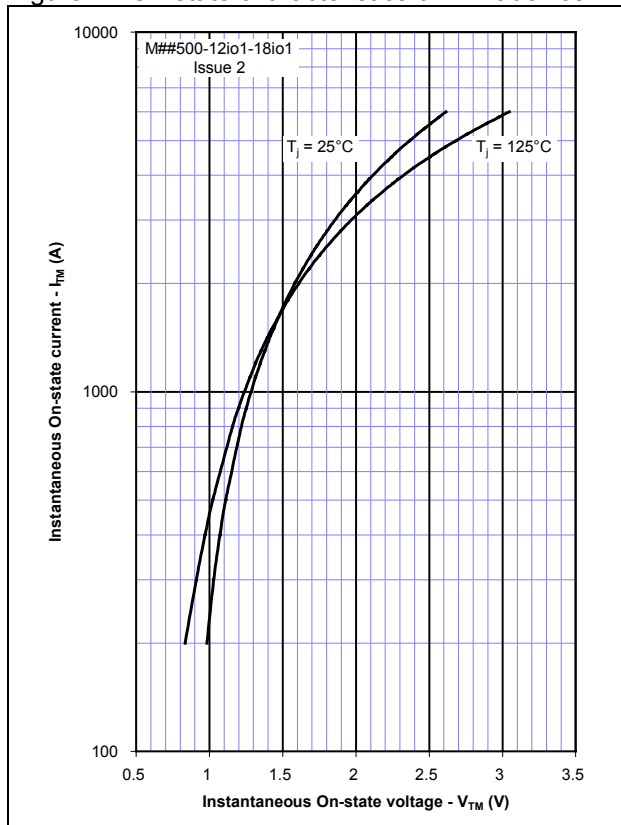

Figure 2 - Transient thermal impedance

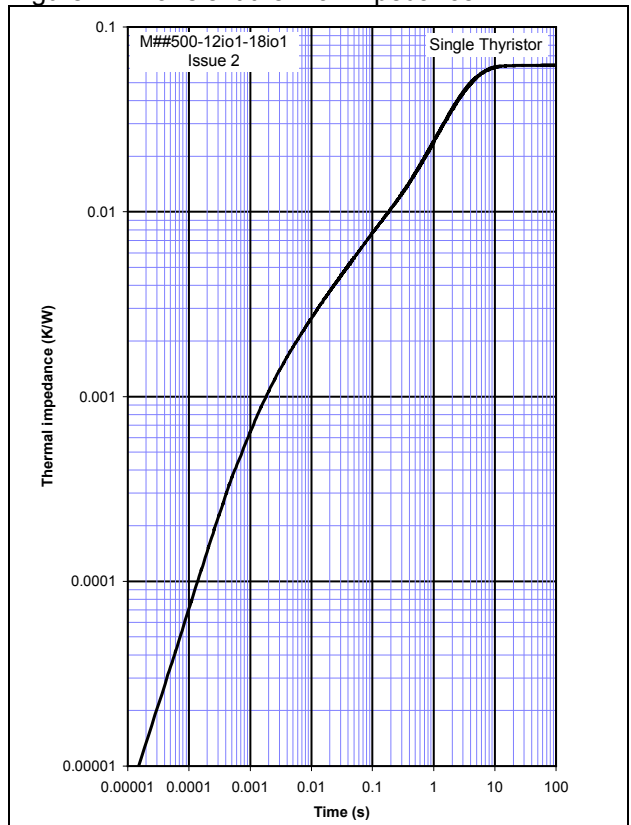

Figure 3 - Gate characteristics - Trigger limits

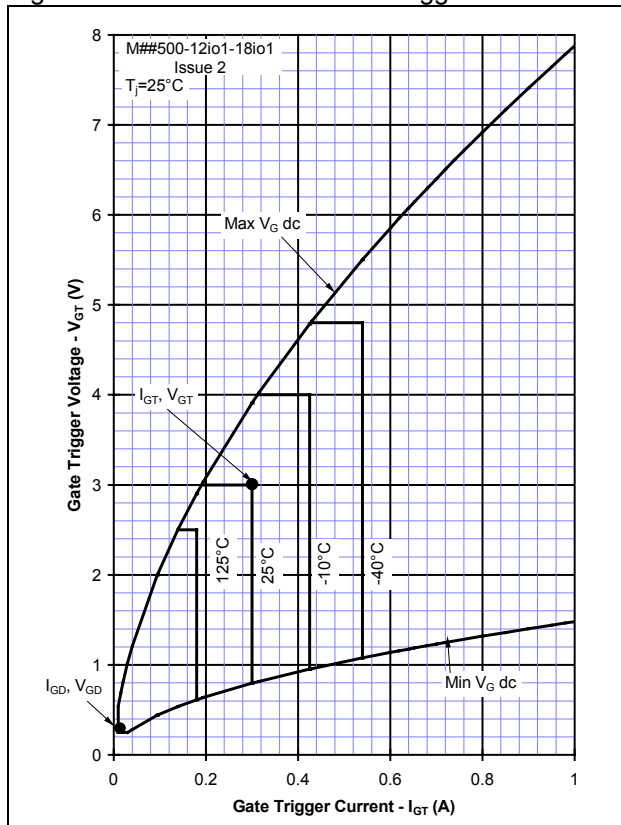

Figure 4 - Gate characteristics - Power curves

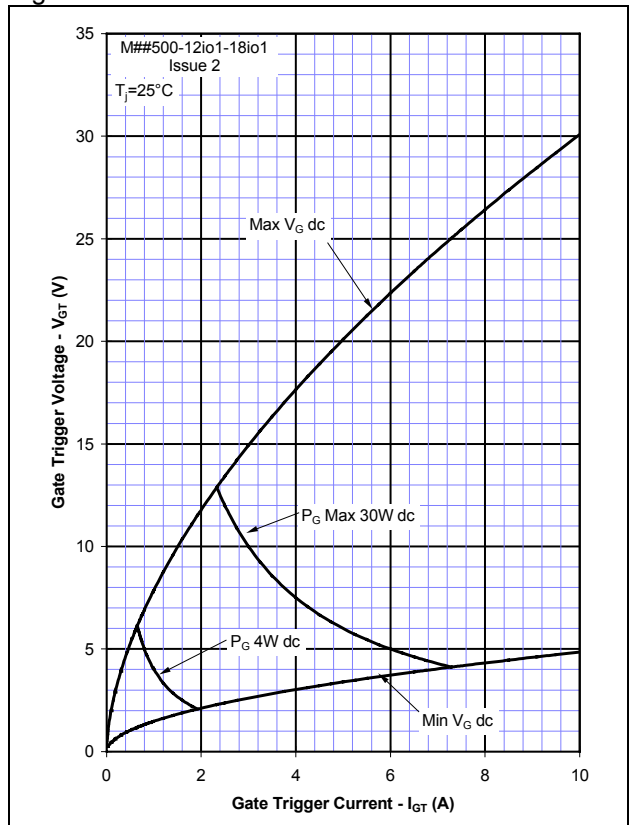

Figure 5 - Total recovered charge, Q_{rr}

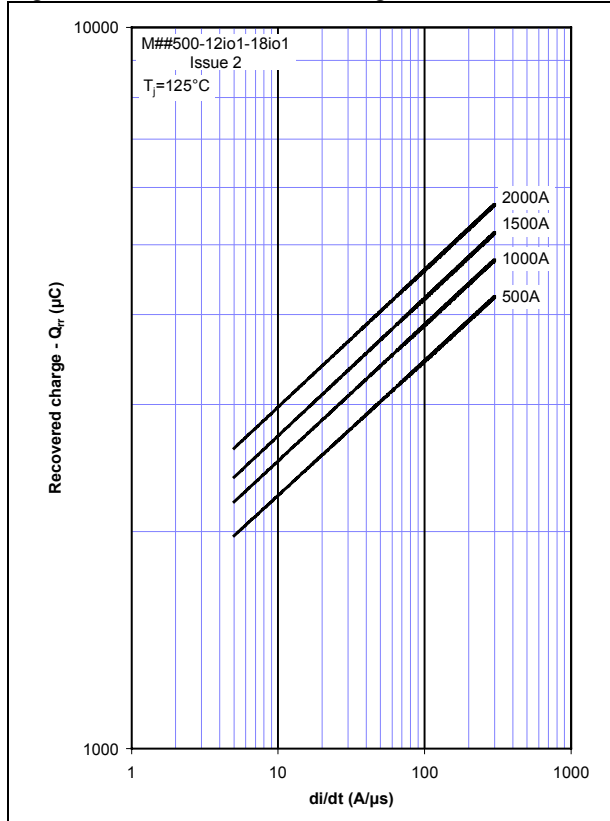

Figure 6 - Recovered charge, Q_{ra} (50% chord)

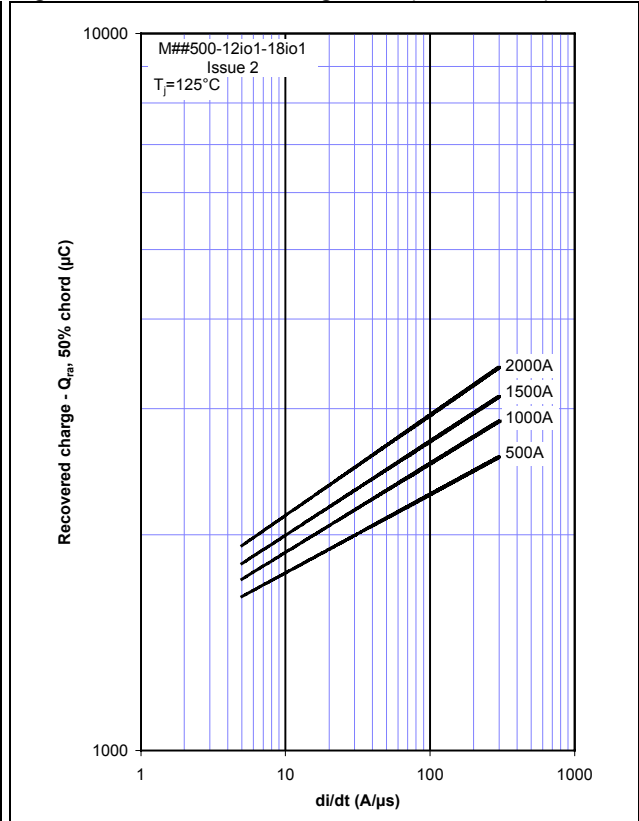

Figure 7 - Peak reverse recovery current, I_{rm}

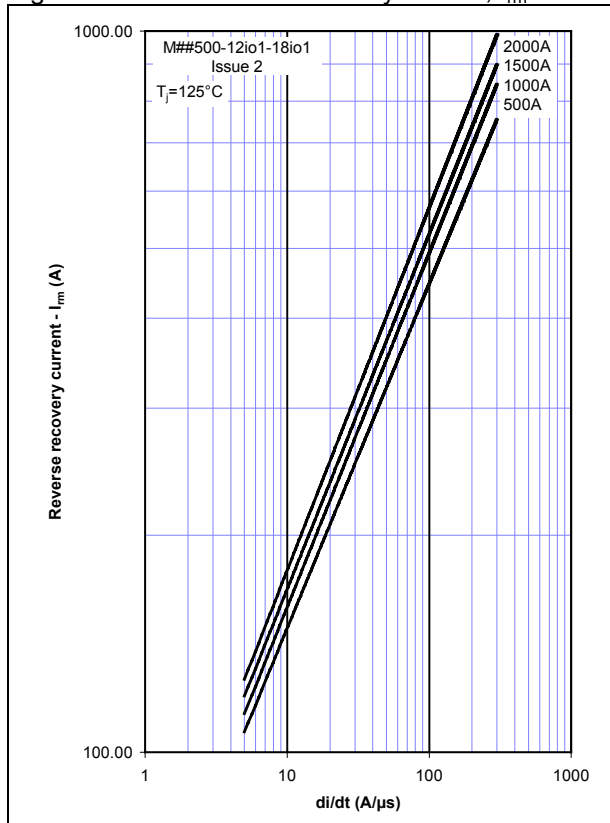

Figure 8 - Maximum recovery time, t_{rr} (50% chord)

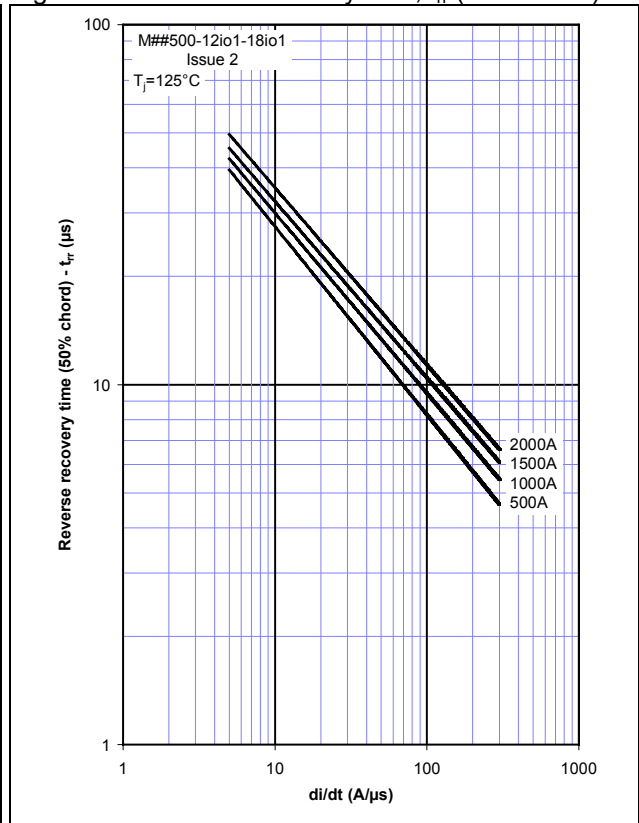

Figure 9 - On-state current vs. Power dissipation - Sine wave

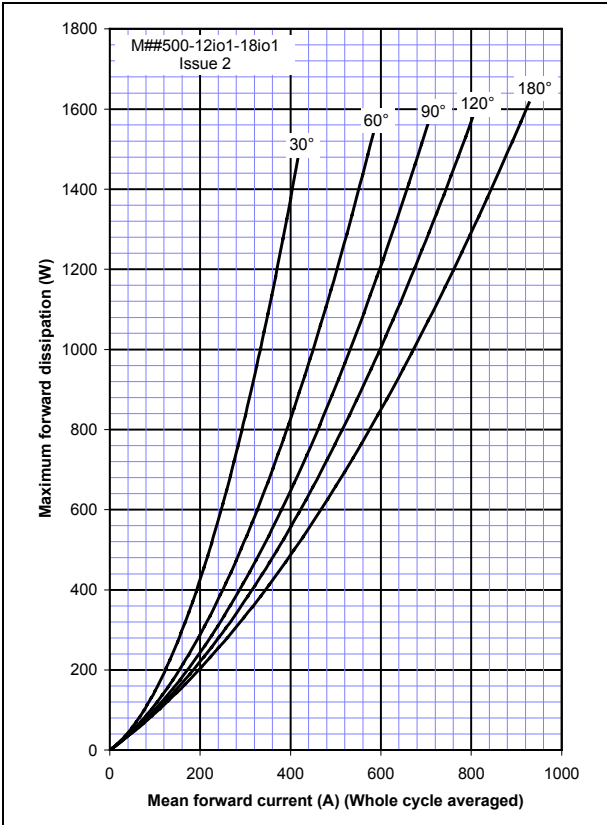

Figure 10 - On-state current vs. Heatsink temperature - Sine wave

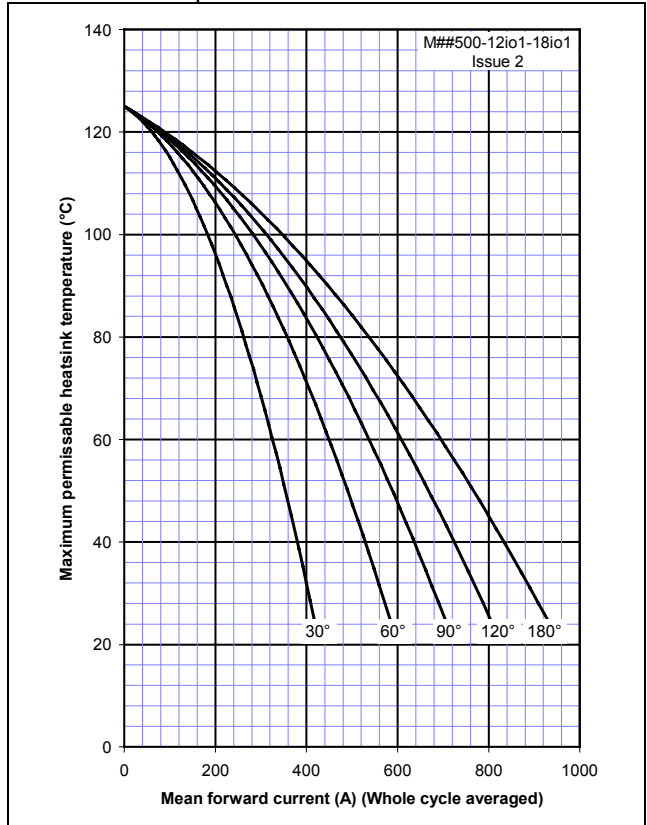

Figure 11 - On-state current vs. Power dissipation - Square wave

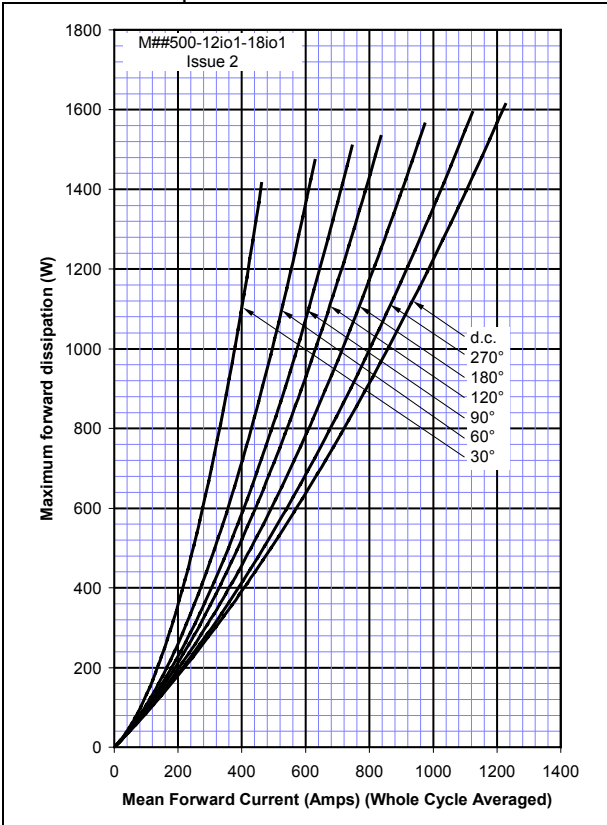

Figure 12 - On-state current vs. Heatsink temperature - Square wave

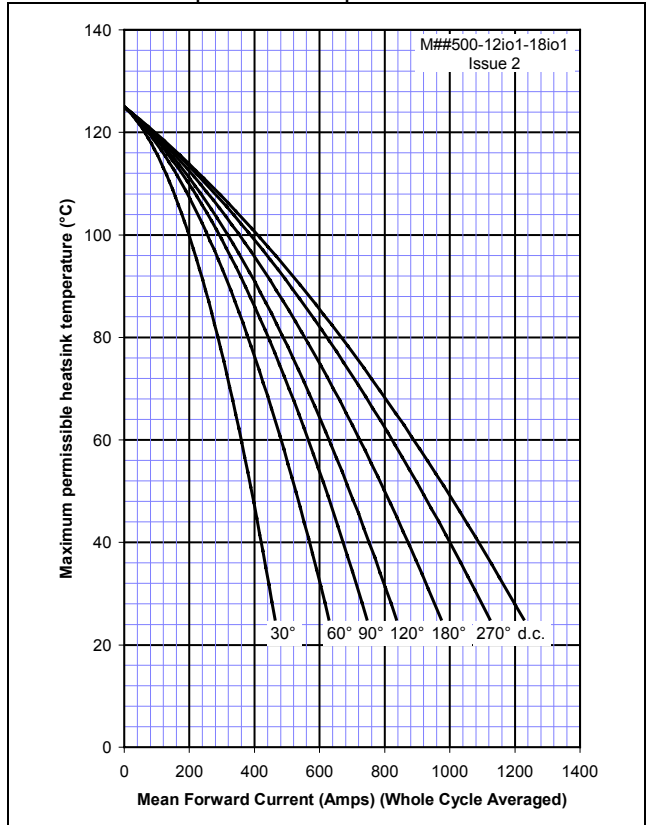
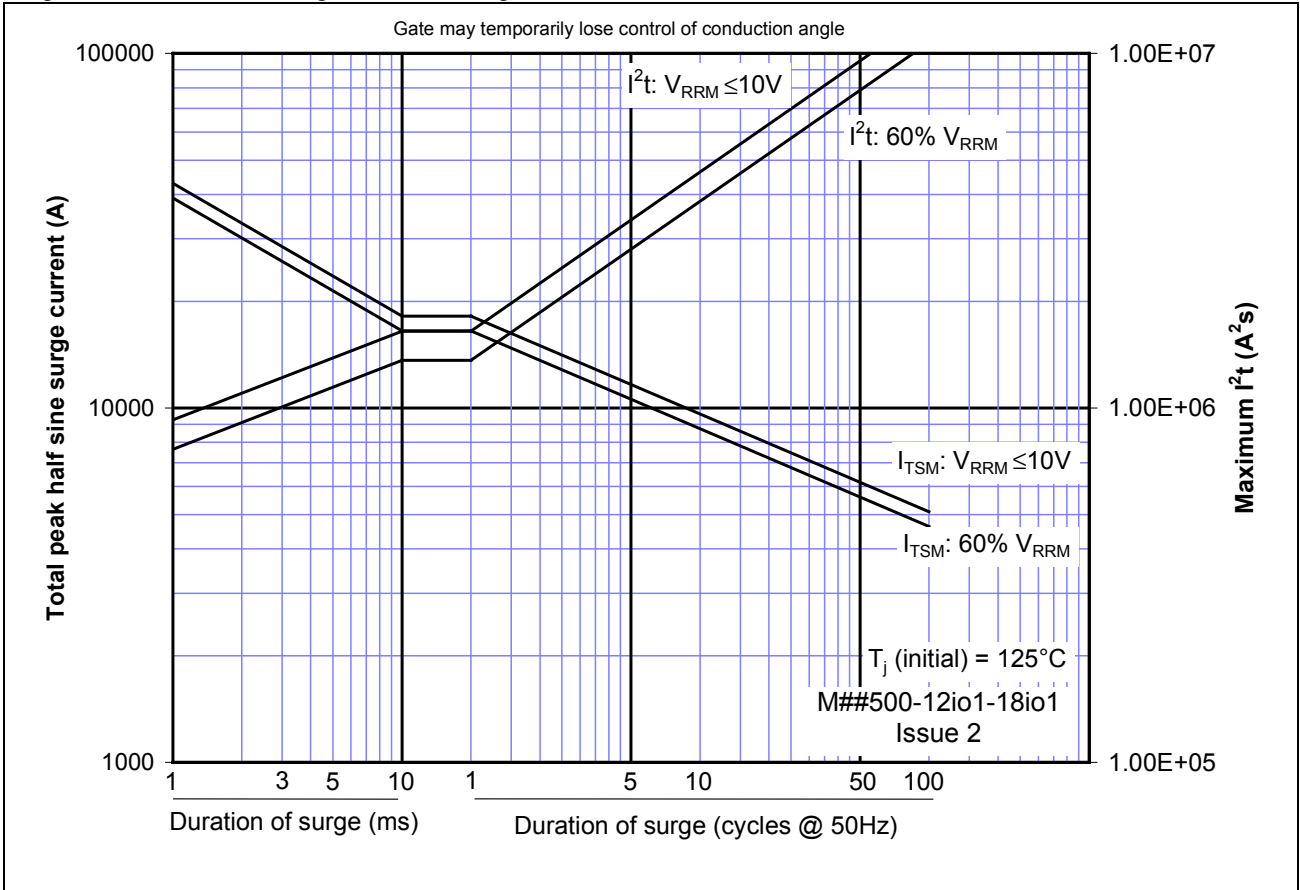

Figure 13 - Maximum surge and I²t Ratings



Diode curves

Figure 14 - Instantaneous forward voltage V_F

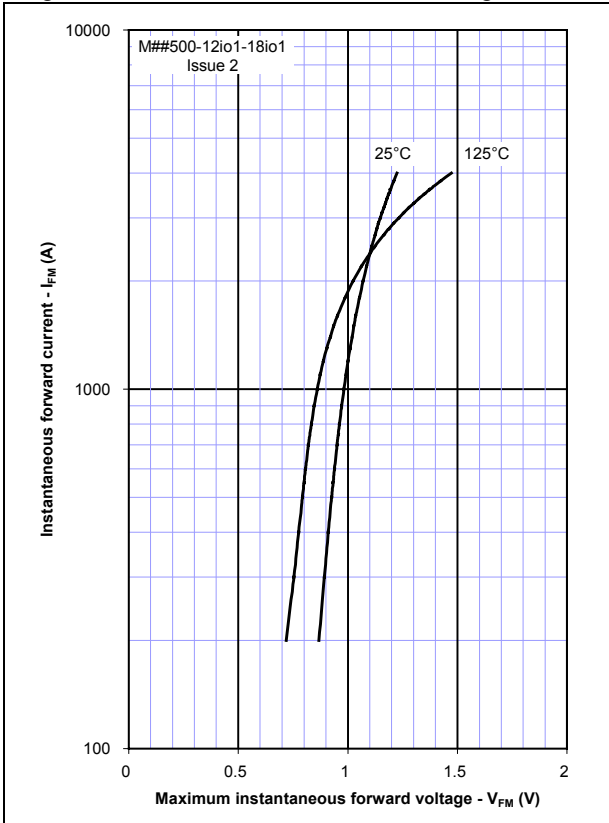

Figure 15 - Transient thermal impedance

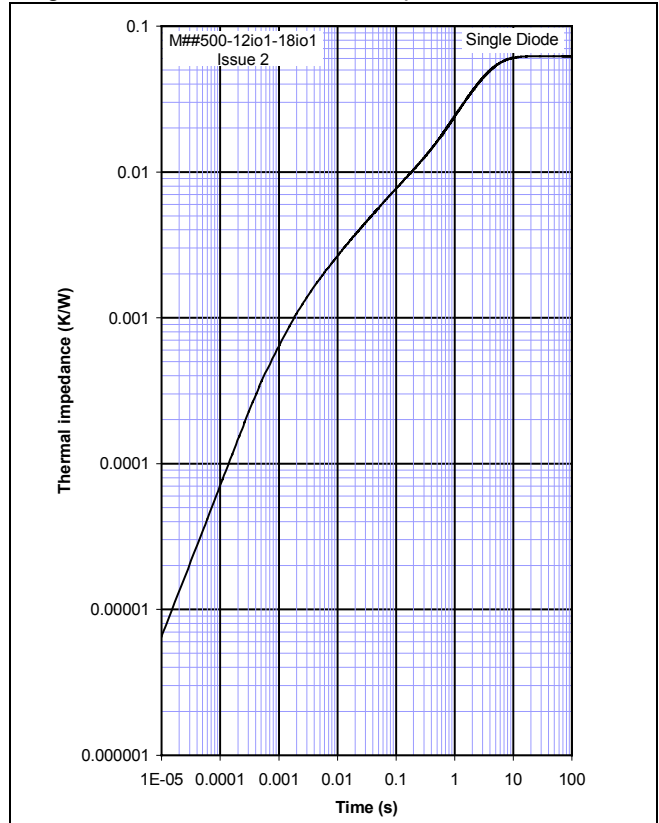

Figure 16 - Total recovered charge, Q_{rr}

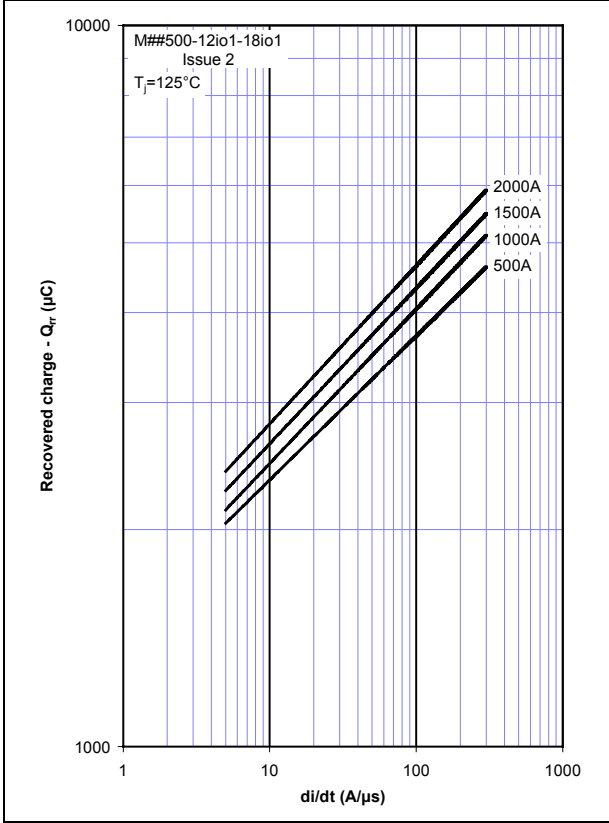

Figure 17 - Recovered charge, Q_{ra} (50% chord)

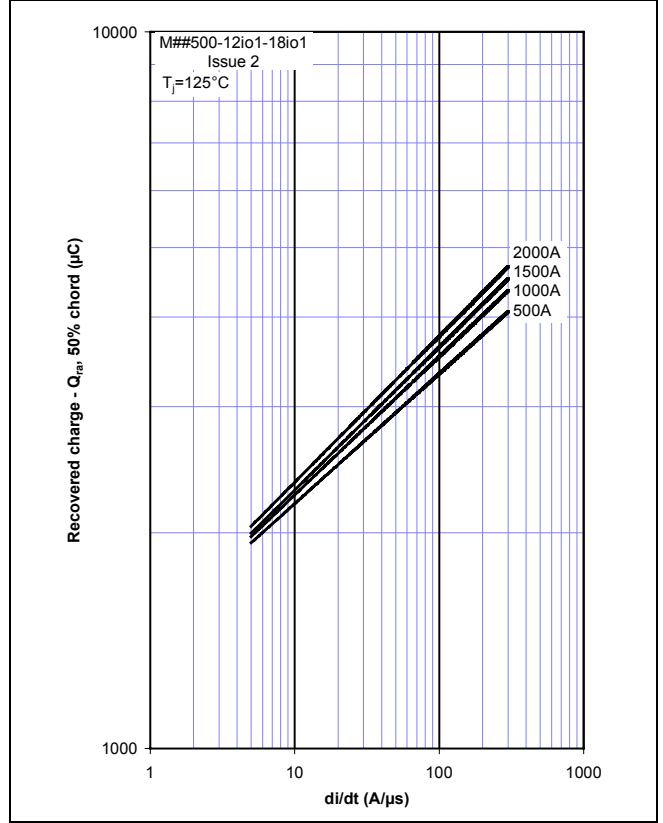

Figure 18 - Peak reverse recovery current, I_{rm}

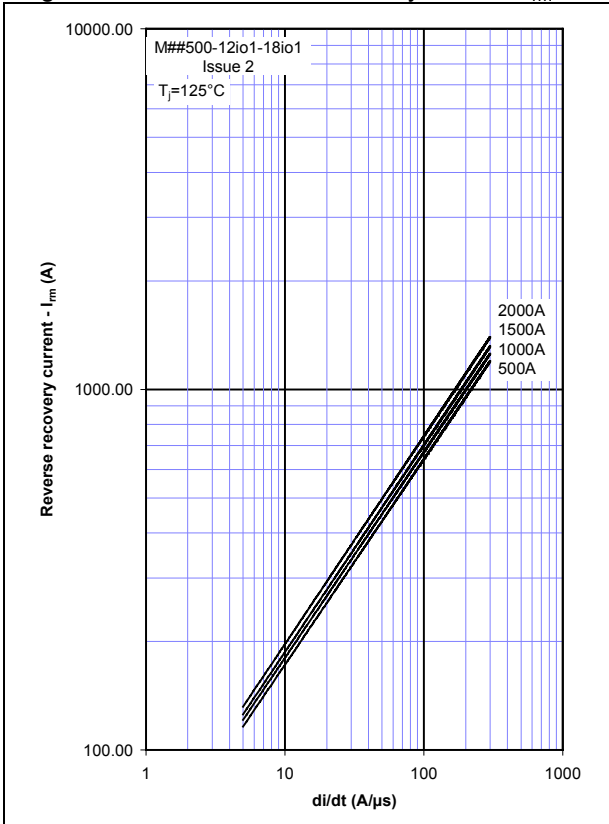
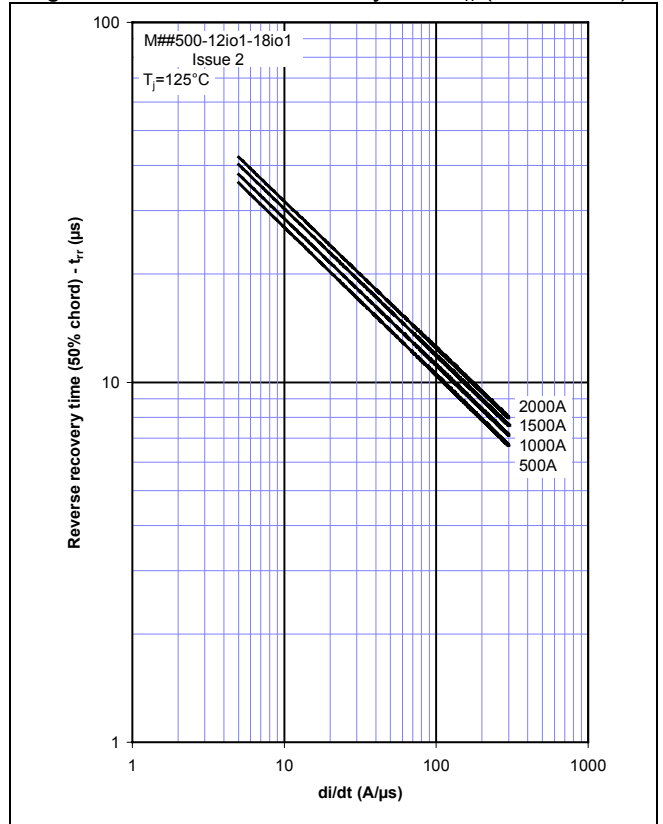
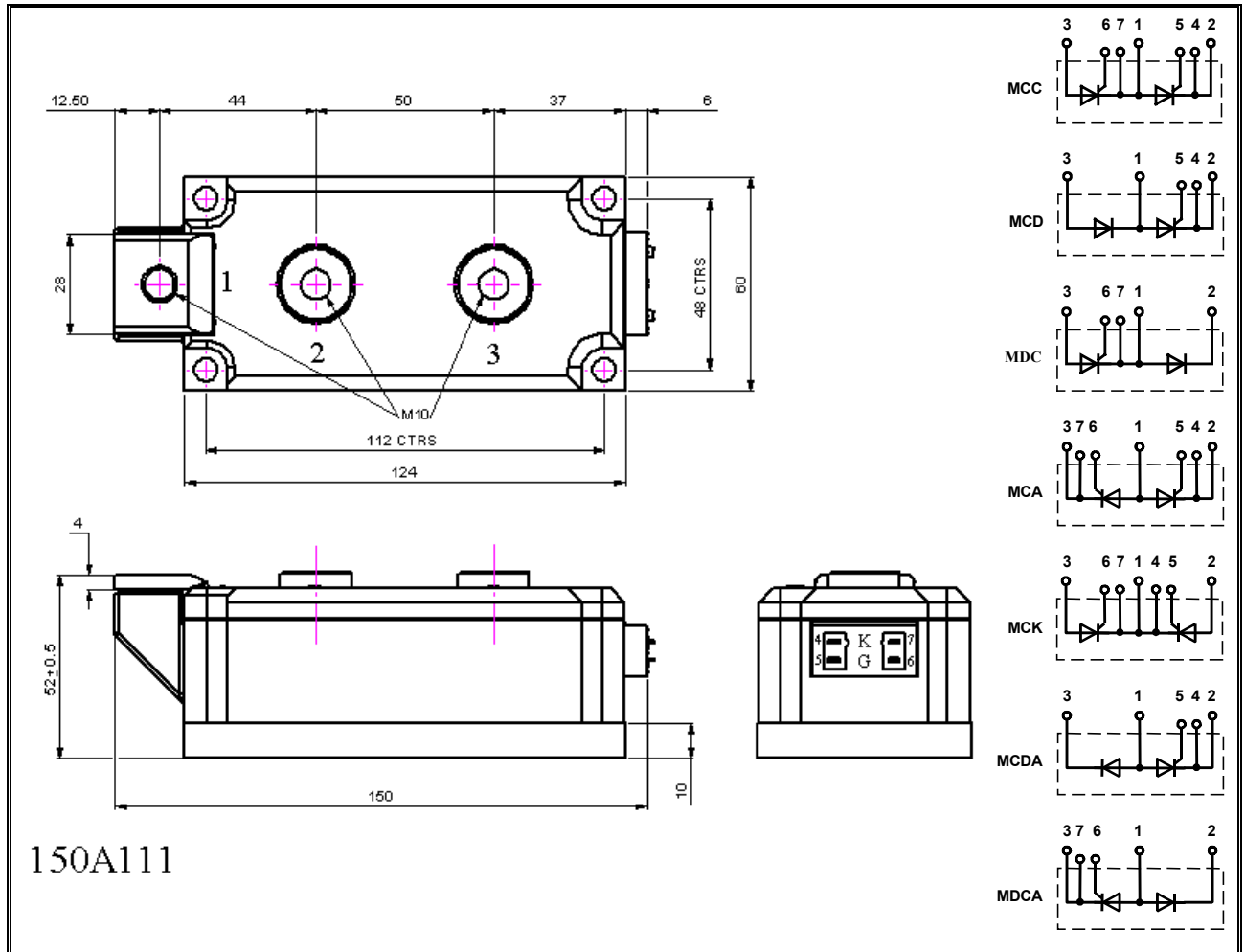

Figure 19 - Maximum recovery time, t_{rr} (50% chord)



Outline Drawing & Ordering Information



150A111

ORDERING INFORMATION

(Please quote 11 digit code as below)

M	##	500	◆◆	io	1
Fixed Type Code	Configuration code CC, CD, DC, CA, CK, CDA, DCA	Average Current Rating	Voltage code V _{RRM} /100 12-18	i = Critical dv/dt 1000 V/μs o = Typical turn-off time	Fixed Version Code

Order code: MCD500-14io1 – MCD configuration, 1400V V_{RRM}

IXYS Semiconductor GmbH
Edisonstraße 15
D-68623 Lampertheim
Tel: +49 6206 503-0
Fax: +49 6206 503-627
E-mail: marcom@ixys.de

IXYS Corporation
3540 Bassett Street
Santa Clara CA 95054 USA
Tel: +1 (408) 982 0700
Fax: +1 (408) 496 0670
E-mail: sales@ixys.net



www.ixys.com



An IXYS Company

www.westcode.com

Westcode Semiconductors Ltd
Langley Park Way, Langley Park,
Chippenham, Wiltshire, SN15 1GE.
Tel: +44 (0)1249 444524
Fax: +44 (0)1249 659448
E-mail: WSL.sales@westcode.com

Westcode Semiconductors Inc
3270 Cherry Avenue
Long Beach CA 90807 USA
Tel: +1 (562) 595 6971
Fax: +1 (562) 595 8182
E-mail: WSI.sales@westcode.com

The information contained herein is confidential and is protected by Copyright. The information may not be used or disclosed except with the written permission of and in the manner permitted by the proprietors IXYS Semiconductors GmbH.

© IXYS Semiconductor GmbH.

In the interest of product improvement, IXYS reserves the right to change specifications at any time without prior notice.

Devices with a suffix code (2-letter, 3-letter or letter/digit/letter combination) added to their generic code are not necessarily subject to the conditions and limits contained in this report.