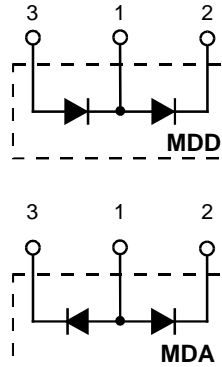
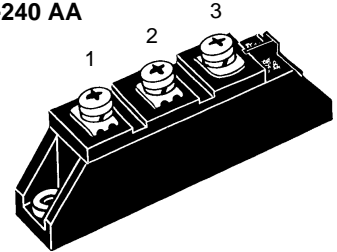

# Diode Modules

$I_{FRMS} = 2 \times 180 \text{ A}$   
 $I_{FAVM} = 2 \times 113 \text{ A}$   
 $V_{RRM} = 800-1800 \text{ V}$

$V_{RSM}$ V	$V_{RRM}$ V	Type	
900	800	MDD 72-08N1 B	MDA 72-08N1 B
1300	1200	MDD 72-12N1 B	---
1500	1400	MDD 72-14N1 B	MDA 72-14N1 B
1700	1600	MDD 72-16N1 B	MDA 72-16N1 B
1900	1800	MDD 72-18N1 B	---

**TO-240 AA**

Symbol	Test Conditions	Maximum Ratings	
$I_{FRMS}$	$T_{VJ} = T_{VJM}$	180 A	
$I_{FAVM}$	$T_C = 92^\circ\text{C}; 180^\circ \text{ sine}$	113 A	
	$T_C = 100^\circ\text{C}; 180^\circ \text{ sine}$	99 A	
$I_{FSM}$	$T_{VJ} = 45^\circ\text{C}; V_R = 0$	t = 10 ms (50 Hz), sine	1700 A
		t = 8.3 ms (60 Hz), sine	1950 A
	$T_{VJ} = T_{VJM}; V_R = 0$	t = 10 ms (50 Hz), sine	1540 A
		t = 8.3 ms (60 Hz), sine	1800 A
$\int i^2 dt$	$T_{VJ} = 45^\circ\text{C}; V_R = 0$	t = 10 ms (50 Hz), sine	14 450 A <sup>2</sup> s
		t = 8.3 ms (60 Hz), sine	15 700 A <sup>2</sup> s
	$T_{VJ} = T_{VJM}; V_R = 0$	t = 10 ms (50 Hz), sine	11 850 A <sup>2</sup> s
		t = 8.3 ms (60 Hz), sine	13 400 A <sup>2</sup> s
$T_{VJ}$		-40...+150 °C	
$T_{VJM}$		150 °C	
$T_{stg}$		-40...+125 °C	
$V_{ISOL}$	50/60 Hz, RMS	t = 1 min	3000 V~
	$I_{ISOL} \leq 1 \text{ mA}$	t = 1 s	3600 V~
$M_d$	Mounting torque (M5)		2.5-4/22-35 Nm/lb.in.
	Terminal connection torque (M5)		2.5-4/22-35 Nm/lb.in.
Weight	Typical including screws		90 g

### Features

- International standard package JEDEC TO-240 AA
- Direct copper bonded  $\text{Al}_2\text{O}_3$  -ceramic base plate
- Planar passivated chips
- Isolation voltage 3600 V~
- UL registered, E 72873

### Applications

- Supplies for DC power equipment
- DC supply for PWM inverter
- Field supply for DC motors
- Battery DC power supplies

### Advantages

- Space and weight savings
- Simple mounting
- Improved temperature and power cycling
- Reduced protection circuits

### Dimensions in mm (1 mm = 0.0394")

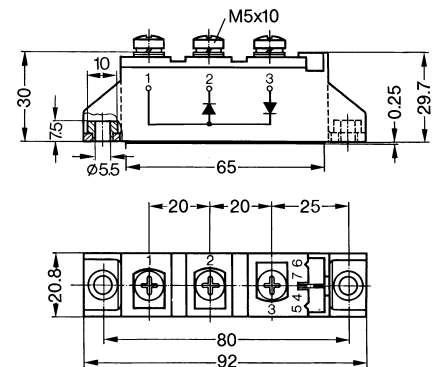

Symbol	Test Conditions	Characteristic Values
$I_R$	$T_{VJ} = T_{VJM}; V_R = V_{RRM}$	15 mA
$V_F$	$I_F = 300 \text{ A}; T_{VJ} = 25^\circ\text{C}$	1.6 V
$V_{T0}$	For power-loss calculations only	0.8 V
$r_T$	$T_{VJ} = T_{VJM}$	2.3 mΩ
$Q_S$	$T_{VJ} = 125^\circ\text{C}; I_F = 50 \text{ A}, -di/dt = 3 \text{ A}/\mu\text{s}$	170 μC
$I_{RM}$		45 A
$R_{thJC}$	per diode; DC current } other values per module } see Fig. 6/7	0.35 K/W
		0.175 K/W
		0.55 K/W
		0.275 K/W
$d_s$	Creepage distance on surface	12.7 mm
$d_A$	Strike distance through air	9.6 mm
$a$	Maximum allowable acceleration	50 m/s <sup>2</sup>

Data according to IEC 60747 and refer to a single diode unless otherwise stated. IXYS reserves the right to change limits, test conditions and dimensions

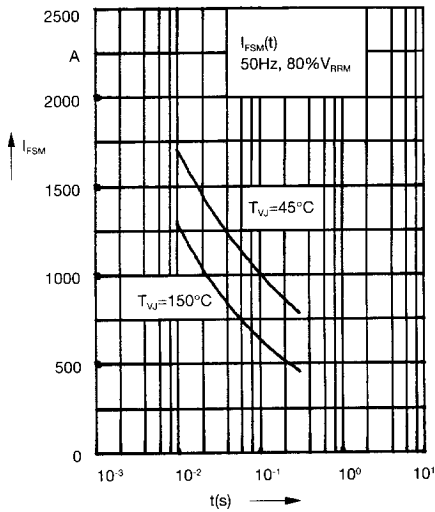

Fig. 1 Surge overload current  
 $I_{FSM}$ : Crest value, t: duration

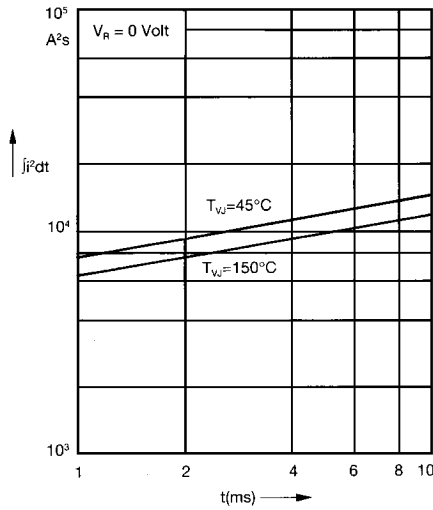

Fig. 2  $\int i^2 dt$  versus time (1-10 ms)

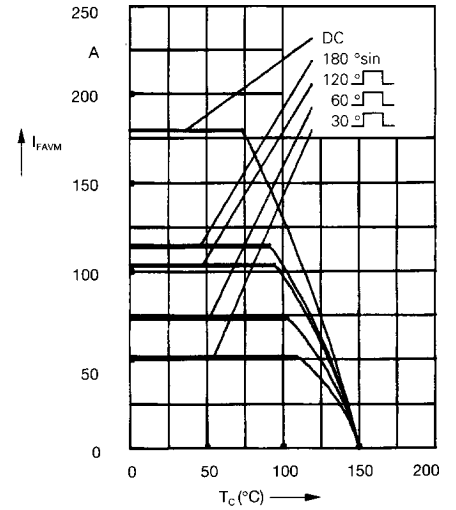

Fig. 2a Maximum forward current at case temperature

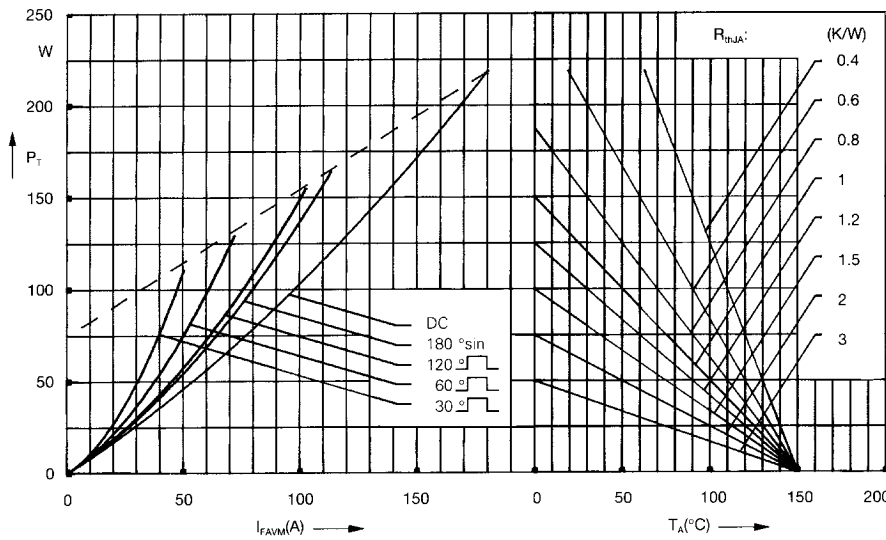

Fig. 3 Power dissipation versus forward current and ambient temperature (per diode)

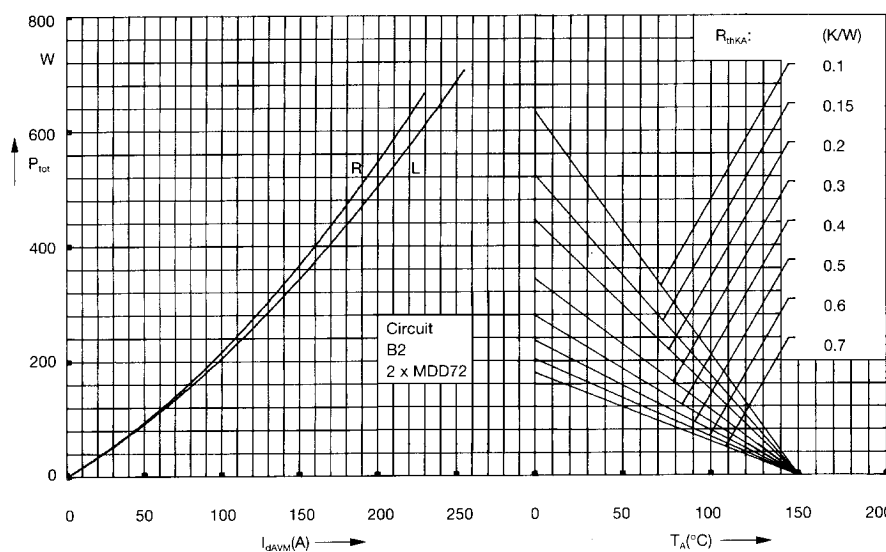

Fig. 4 Single phase rectifier bridge:  
Power dissipation versus direct output current and ambient temperature  
R = resistive load  
L = inductive load

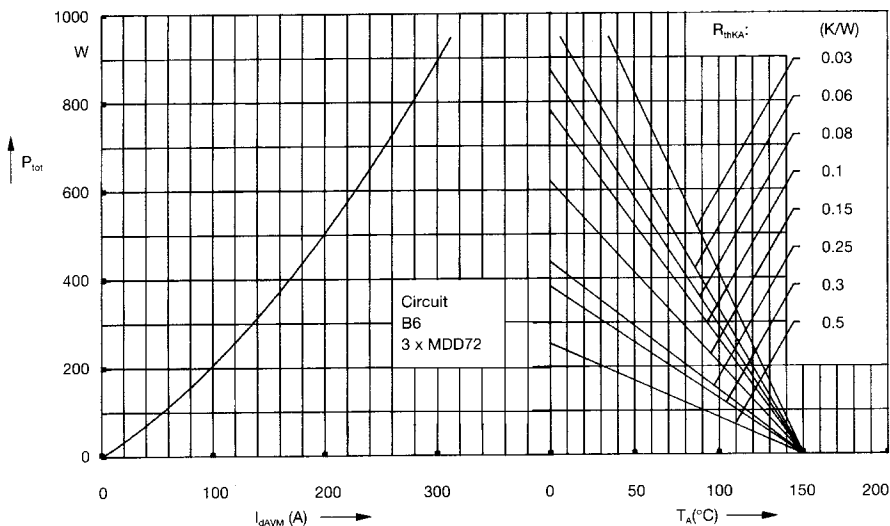

Fig. 5 Three phase rectifier bridge: Power dissipation versus direct output current and ambient temperature

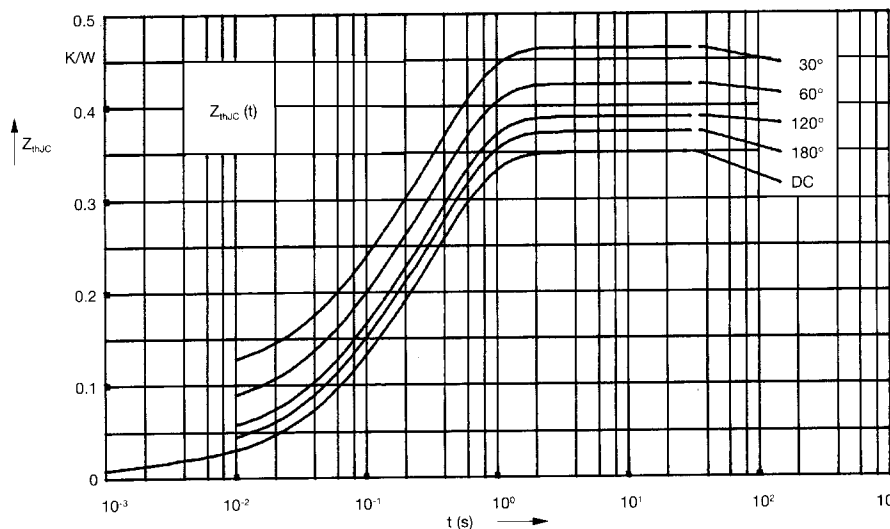

Fig. 6 Transient thermal impedance junction to case (per diode)

$R_{thJC}$  for various conduction angles d:

d	$R_{thJC}$ (K/W)
DC	0.35
180°	0.37
120°	0.39
60°	0.43
30°	0.47

Constants for  $Z_{thJC}$  calculation:

i	$R_{thi}$ (K/W)	$t_i$ (s)
1	0.013	0.0014
2	0.072	0.062
3	0.265	0.375

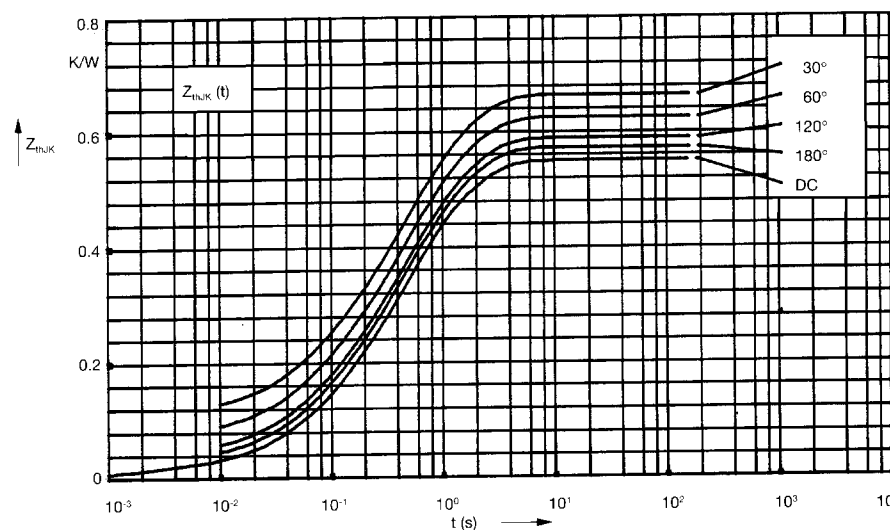

Fig. 7 Transient thermal impedance junction to heatsink (per diode)

$R_{thJK}$  for various conduction angles d:

d	$R_{thJK}$ (K/W)
DC	0.55
180°	0.57
120°	0.59
60°	0.63
30°	0.67

Constants for  $Z_{thJK}$  calculation:

i	$R_{thi}$ (K/W)	$t_i$ (s)
1	0.013	0.0014
2	0.072	0.062
3	0.265	0.375
4	0.2	1.32