

Vorläufige Daten
preliminary data

IGBT-Wechselrichter/IGBT-inverter
Höchstzulässige Werte/maximum rated values

Kollektor-Emitter-Sperrspannung collector-emitter voltage	$T_{vj} = 25^{\circ}\text{C}$ $T_{vj} = -25^{\circ}\text{C}$	V_{CES}	3300 3300	V
Kollektor-Dauergleichstrom DC-collector current	$T_C = 80^{\circ}\text{C}$ $T_C = 25^{\circ}\text{C}$	$I_{C\ nom}$ I_C	200 330	A A
Periodischer Kollektor Spitzenstrom repetitive peak collector current	$t_P = 1\ \text{ms}$, $T_C = 80^{\circ}\text{C}$	I_{CRM}	400	A
Gesamt-Verlustleistung total power dissipation	$T_C = 25^{\circ}\text{C}$	P_{tot}	2,20	kW
Gate-Emitter-Spitzenspannung gate-emitter peak voltage		V_{GES}	+/-20	V

Charakteristische Werte/characteristic values

			min.	typ.	max.	
Kollektor-Emitter Sättigungsspannung collector-emitter saturation voltage	$I_C = 200\ \text{A}$, $V_{GE} = 15\ \text{V}$, $T_{vj} = 25^{\circ}\text{C}$ $I_C = 200\ \text{A}$, $V_{GE} = 15\ \text{V}$, $T_{vj} = 125^{\circ}\text{C}$	$V_{CE\ sat}$		3,40 4,30	4,25 5,00	V V
Gate-Schwellenspannung gate threshold voltage	$I_C = 20,0\ \text{mA}$, $V_{CE} = V_{GE}$, $T_{vj} = 25^{\circ}\text{C}$	V_{GEth}	4,2	5,1	6,0	V
Gateladung gate charge	$V_{GE} = -15\ \text{V} \dots +15\ \text{V}$, $V_{CE} = 1800\ \text{V}$	Q_G		4,00		μC
Interner Gatewiderstand internal gate resistor	$T_{vj} = 25^{\circ}\text{C}$	R_{Gint}		2,5		Ω
Eingangskapazität input capacitance	$f = 1\ \text{MHz}$, $T_{vj} = 25^{\circ}\text{C}$, $V_{CE} = 25\ \text{V}$, $V_{GE} = 0\ \text{V}$	C_{ies}		25,0		nF
Rückwirkungskapazität reverse transfer capacitance	$f = 1\ \text{MHz}$, $T_{vj} = 25^{\circ}\text{C}$, $V_{CE} = 25\ \text{V}$, $V_{GE} = 0\ \text{V}$	C_{res}		1,40		nF
Kollektor-Emitter Reststrom collector-emitter cut-off current	$V_{CE} = 3300\ \text{V}$, $V_{GE} = 0\ \text{V}$, $T_{vj} = 25^{\circ}\text{C}$	I_{CES}			5,0	mA
Gate-Emitter Reststrom gate-emitter leakage current	$V_{CE} = 0\ \text{V}$, $V_{GE} = 20\ \text{V}$, $T_{vj} = 25^{\circ}\text{C}$	I_{GES}			400	nA
Einschaltverzögerungszeit (ind. Last) turn-on delay time (inductive load)	$I_C = 200\ \text{A}$, $V_{CE} = 1800\ \text{V}$ $V_{GE} = \pm 15\ \text{V}$, $R_{Gon} = 5,6\ \Omega$, $C_{GE} = 33,0\ \text{nF}$, $T_{vj} = 25^{\circ}\text{C}$ $V_{GE} = \pm 15\ \text{V}$, $R_{Gon} = 5,6\ \Omega$, $C_{GE} = 33,0\ \text{nF}$, $T_{vj} = 125^{\circ}\text{C}$	$t_{d\ on}$		0,28 0,28		μs μs
Anstiegszeit (induktive Last) rise time (inductive load)	$I_C = 200\ \text{A}$, $V_{CE} = 1800\ \text{V}$ $V_{GE} = \pm 15\ \text{V}$, $R_{Gon} = 5,6\ \Omega$, $C_{GE} = 33,0\ \text{nF}$, $T_{vj} = 25^{\circ}\text{C}$ $V_{GE} = \pm 15\ \text{V}$, $R_{Gon} = 5,6\ \Omega$, $C_{GE} = 33,0\ \text{nF}$, $T_{vj} = 125^{\circ}\text{C}$	t_r		0,18 0,20		μs μs
Abschaltverzögerungszeit (ind. Last) turn-off delay time (inductive load)	$I_C = 200\ \text{A}$, $V_{CE} = 1800\ \text{V}$ $V_{GE} = \pm 15\ \text{V}$, $R_{Goff} = 7,5\ \Omega$, $C_{GE} = 33,0\ \text{nF}$, $T_{vj} = 25^{\circ}\text{C}$ $V_{GE} = \pm 15\ \text{V}$, $R_{Goff} = 7,5\ \Omega$, $C_{GE} = 33,0\ \text{nF}$, $T_{vj} = 125^{\circ}\text{C}$	$t_{d\ off}$		1,55 1,70		μs μs
Fallzeit (induktive Last) fall time (inductive load)	$I_C = 200\ \text{A}$, $V_{CE} = 1800\ \text{V}$ $V_{GE} = \pm 15\ \text{V}$, $R_{Goff} = 7,5\ \Omega$, $C_{GE} = 33,0\ \text{nF}$, $T_{vj} = 25^{\circ}\text{C}$ $V_{GE} = \pm 15\ \text{V}$, $R_{Goff} = 7,5\ \Omega$, $C_{GE} = 33,0\ \text{nF}$, $T_{vj} = 125^{\circ}\text{C}$	t_f		0,20 0,20		μs μs
Einschaltverlustenergie pro Puls turn-on energy loss per pulse	$I_C = 200\ \text{A}$, $V_{CE} = 1800\ \text{V}$, $L_S = 70\ \text{nH}$ $V_{GE} = \pm 15\ \text{V}$, $R_{Gon} = 5,6\ \Omega$, $C_{GE} = 33,0\ \text{nF}$, $T_{vj} = 25^{\circ}\text{C}$ $V_{GE} = \pm 15\ \text{V}$, $R_{Gon} = 5,6\ \Omega$, $C_{GE} = 33,0\ \text{nF}$, $T_{vj} = 125^{\circ}\text{C}$	E_{on}		235 365		mJ mJ
Abschaltverlustenergie pro Puls turn-off energy loss per pulse	$I_C = 200\ \text{A}$, $V_{CE} = 1800\ \text{V}$, $L_S = 70\ \text{nH}$ $V_{GE} = \pm 15\ \text{V}$, $R_{Goff} = 7,5\ \Omega$, $C_{GE} = 33,0\ \text{nF}$, $T_{vj} = 25^{\circ}\text{C}$ $V_{GE} = \pm 15\ \text{V}$, $R_{Goff} = 7,5\ \Omega$, $C_{GE} = 33,0\ \text{nF}$, $T_{vj} = 125^{\circ}\text{C}$	E_{off}		215 255		mJ mJ
Kurzschlußverhalten SC data	$t_P \leq 10\ \mu\text{s}$, $V_{GE} \leq 15\ \text{V}$ $T_{vj} \leq 125^{\circ}\text{C}$, $V_{CC} = 2500\ \text{V}$, $V_{CEmax} = V_{CES} - L_{sCE} \cdot di/dt$	I_{SC}		1000		A
Innerer Wärmewiderstand thermal resistance, junction to case	pro IGBT per IGBT	R_{thJC}			57,0	K/kW
Übergangs-Wärmewiderstand thermal resistance, case to heatsink	pro IGBT / per IGBT $\lambda_{Paste} = 1\ \text{W}/(\text{m}\cdot\text{K})$ / $\lambda_{grease} = 1\ \text{W}/(\text{m}\cdot\text{K})$	R_{thCH}		49,0		K/kW

prepared by: Jürgen Biermann	date of publication: 2003-6-12
approved by: Christoph Lübke	revision: 2.0

Vorläufige Daten
preliminary data

Diode-Wechselrichter/diode-inverter
Höchstzulässige Werte/maximum rated values

Periodische Spitzensperrspannung repetitive peak reverse voltage	$T_{vj} = 25^{\circ}\text{C}$ $T_{vj} = -25^{\circ}\text{C}$	V_{RRM}	3300 3300	V
Dauergleichstrom DC forward current		I_F	200	A
Periodischer Spitzenstrom repetitive peak forward current	$t_P = 1 \text{ ms}$	I_{FRM}	400	A
Grenzlastintegral I^2t - value	$V_R = 0 \text{ V}, t_P = 10 \text{ ms}, T_{vj} = 125^{\circ}\text{C}$	I^2t	14,0	kA^2s
Spitzenverlustleistung maximum power dissipation	$T_{vj} = 125^{\circ}\text{C}$	P_{RQM}	400	kW
Mindesteinschaltdauer minimum turn-on time		$t_{Fon \text{ min}}$	10,0	μs

Charakteristische Werte/characteristic values

			min.	typ.	max.	
Durchlassspannung forward voltage	$I_F = 200 \text{ A}, V_{GE} = 0 \text{ V}, T_{vj} = 25^{\circ}\text{C}$	V_F		2,80	3,50	V
	$I_F = 200 \text{ A}, V_{GE} = 0 \text{ V}, T_{vj} = 125^{\circ}\text{C}$			2,80	3,50	V
Rückstromspitze peak reverse recovery current	$I_F = 200 \text{ A}, -di_F/dt = 1100 \text{ A}/\mu\text{s}$ $V_R = 1800 \text{ V}, V_{GE} = -15 \text{ V}, T_{vj} = 25^{\circ}\text{C}$ $V_R = 1800 \text{ V}, V_{GE} = -15 \text{ V}, T_{vj} = 125^{\circ}\text{C}$	I_{RM}		275 325		A A
Sperrverzögerungsladung recovered charge	$I_F = 200 \text{ A}, -di_F/dt = 1100 \text{ A}/\mu\text{s}$ $V_R = 1800 \text{ V}, V_{GE} = -15 \text{ V}, T_{vj} = 25^{\circ}\text{C}$ $V_R = 1800 \text{ V}, V_{GE} = -15 \text{ V}, T_{vj} = 125^{\circ}\text{C}$	Q_r		120 220		μC μC
Abschaltenergie pro Puls reverse recovery energy	$I_F = 200 \text{ A}, -di_F/dt = 1100 \text{ A}/\mu\text{s}$ $V_R = 1800 \text{ V}, V_{GE} = -15 \text{ V}, T_{vj} = 25^{\circ}\text{C}$ $V_R = 1800 \text{ V}, V_{GE} = -15 \text{ V}, T_{vj} = 125^{\circ}\text{C}$	E_{rec}		125 255		mJ mJ
Innerer Wärmewiderstand thermal resistance, junction to case	pro Diode per diode	R_{thJC}			110	K/kW
Übergangs-Wärmewiderstand thermal resistance, case to heatsink	pro Diode / per diode $\lambda_{\text{Paste}} = 1 \text{ W}/(\text{m}\cdot\text{K})$ / $\lambda_{\text{grease}} = 1 \text{ W}/(\text{m}\cdot\text{K})$	R_{thCH}		93,0		K/kW

prepared by: Jürgen Biermann	date of publication: 2003-6-12
approved by: Christoph Lübke	revision: 2.0

Technische Information/technical information

IGBT-Module
IGBT-modules

FF200R33KF2C



Vorläufige Daten preliminary data

Modul/module

Isolations-Prüfspannung insulation test voltage	RMS, f = 50 Hz, t = 1 min.	V _{ISOL}	6,0		kV
Teilentladungs Aussetzspannung partial discharge extinction voltage	RMS, f = 50 Hz, Q _{PD} ≤ 10 pC (acc. to IEC 1287)	V _{ISOL}	2,6		kV
Kollektor-Emitter-Gleichsperrspannung DC stability	T _{vj} = 25°C, 100 fit	V _{CE D}	1800		V
Material Modulgrundplatte material of module baseplate			AlSiC		
Material für innere Isolation material for internal insulation			AlN		
Kriechstrecke creepage distance	Kontakt - Kühlkörper / terminal to heatsink Kontakt - Kontakt / terminal to terminal		32,0 32,0		mm
Luftstrecke clearance distance	Kontakt - Kühlkörper / terminal to heatsink Kontakt - Kontakt / terminal to terminal		19,0 19,0		mm
Vergleichszahl der Kriechwegbildung comparative tracking index		CTI	> 400		
			min.	typ.	max.
Übergangs-Wärmewiderstand thermal resistance, case to heatsink	pro Modul / per module λ _{Paste} = 1 W/(m·K) / λ _{grease} = 1 W/(m·K)	R _{thCH}	16,0		K/kW
Modulinduktivität stray inductance module		L _{sCE}	58		nH
Modulleitungswiderstand, Anschlüsse - Chip module lead resistance, terminals - chip	T _C = 25°C, pro Zweig / per arm	R _{CC+EE'}	0,78		mΩ
Höchstzulässige Sperrschichttemperatur maximum junction temperature		T _{vj max}			150 °C
Temperatur im Schaltbetrieb temperature under switching conditions		T _{vj op}	-40		125 °C
Lagertemperatur storage temperature		T _{stg}	-40		125 °C
Anzugsdrehmoment f. mech. Befestigung mounting torque	Schraube / screw M6	M	4,25	-	5,75 Nm
Anzugsdrehmoment f. elektr. Anschlüsse terminal connection torque	Schraube / screw M5	M	3,6	-	4,2 Nm
Gewicht weight		G	500		g

Mit dieser technischen Information werden Halbleiterbauelemente spezifiziert, jedoch keine Eigenschaften zugesichert. Sie gilt in Verbindung mit den zugehörigen technischen Erläuterungen.

This technical information specifies semiconductor devices but guarantees no characteristics. It is valid with the appropriate technical explanations.

prepared by: Jürgen Biermann	date of publication: 2003-6-12
approved by: Christoph Lübke	revision: 2.0

Vorläufige Daten
preliminary data

Ausgangskennlinie IGBT-Wechselr. (typisch)
output characteristic IGBT-inverter (typical)
 $I_c = f(V_{CE})$
 $V_{GE} = 15\text{ V}$

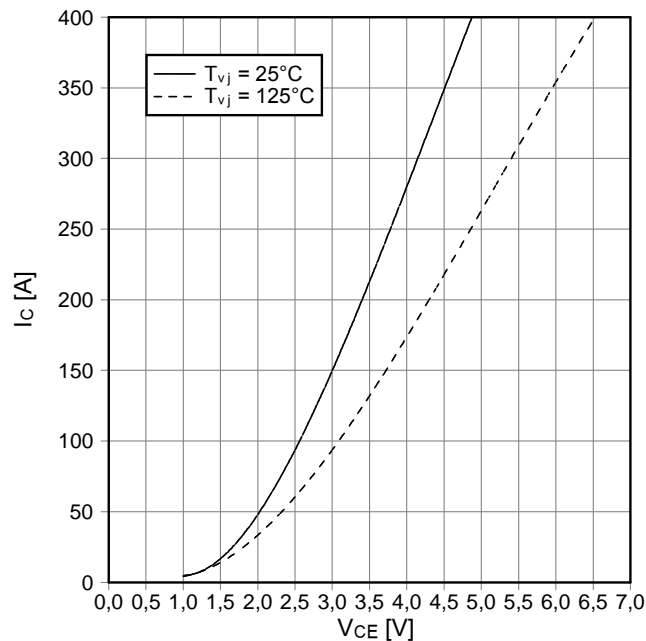

Ausgangskennlinienfeld IGBT-Wechselr. (typisch)
output characteristic IGBT-inverter (typical)
 $I_c = f(V_{CE})$
 $T_{vj} = 125^\circ\text{C}$

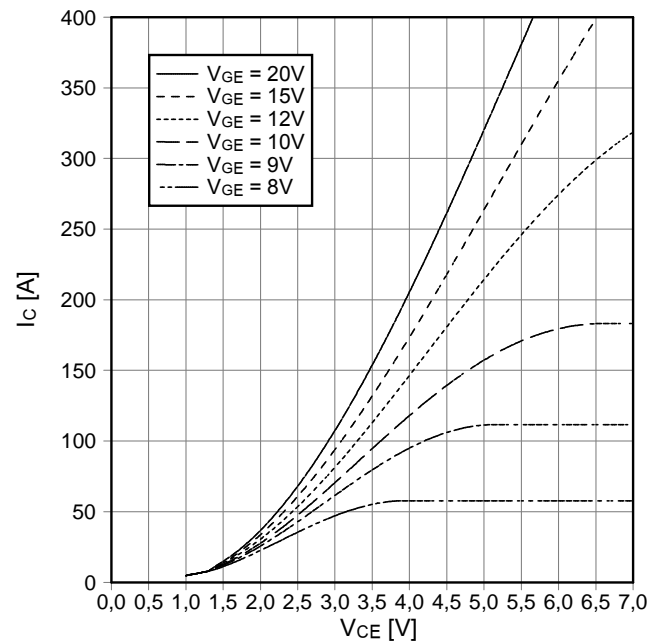

Übertragungscharakteristik IGBT-Wechselr. (typisch)
transfer characteristic IGBT-inverter (typical)
 $I_c = f(V_{GE})$
 $V_{CE} = 20\text{ V}$

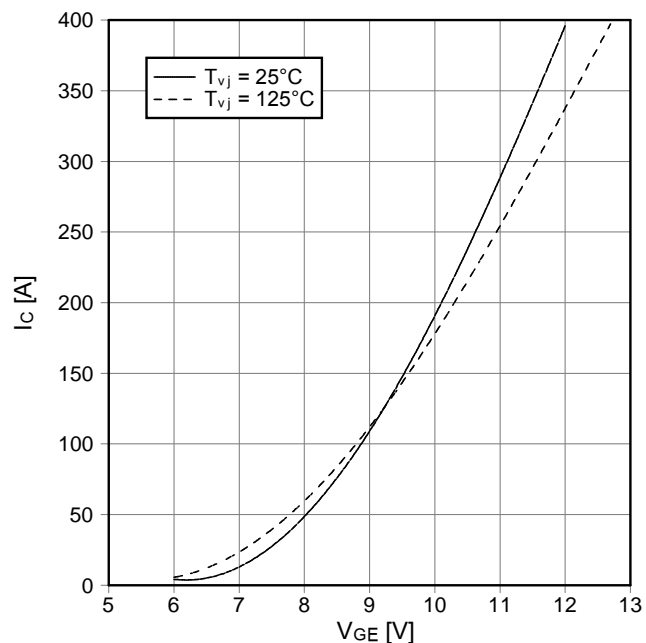

Schaltverluste IGBT-Wechselr. (typisch)
switching losses IGBT-inverter (typical)
 $E_{on} = f(I_c), E_{off} = f(I_c)$
 $V_{GE} = \pm 15\text{ V}, R_{Gon} = 5,6\ \Omega, R_{Goff} = 7,5\ \Omega, V_{CE} = 1800\text{ V},$
 $T_{vj} = 125^\circ\text{C}, C_{GE} = 33\text{ nF}$

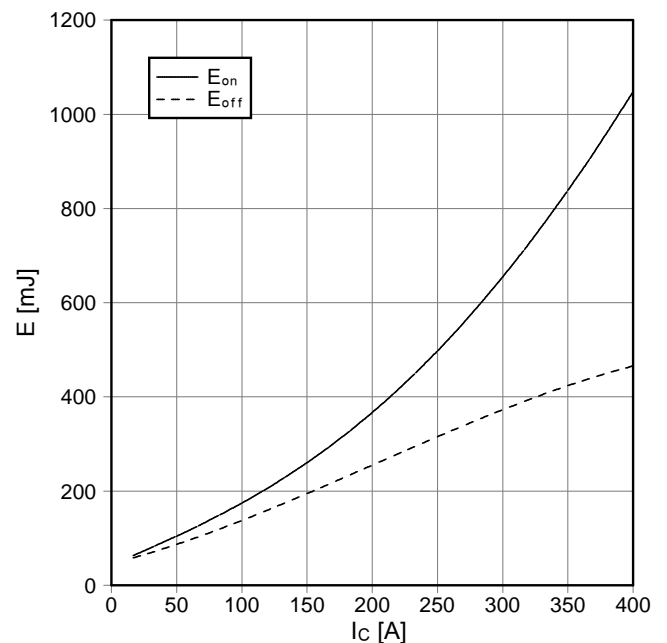

prepared by: Jürgen Biermann	date of publication: 2003-6-12
approved by: Christoph Lübke	revision: 2.0

Vorläufige Daten
preliminary data

Schaltverluste IGBT-Wechselr. (typisch)
switching losses IGBT-Inverter (typical)

$E_{on} = f(R_G)$, $E_{off} = f(R_G)$
 $V_{GE} = \pm 15\text{ V}$, $I_C = 200\text{ A}$, $V_{CE} = 1800\text{ V}$, $T_{vj} = 125^\circ\text{C}$,
 $C_{GE} = 33\text{ nF}$

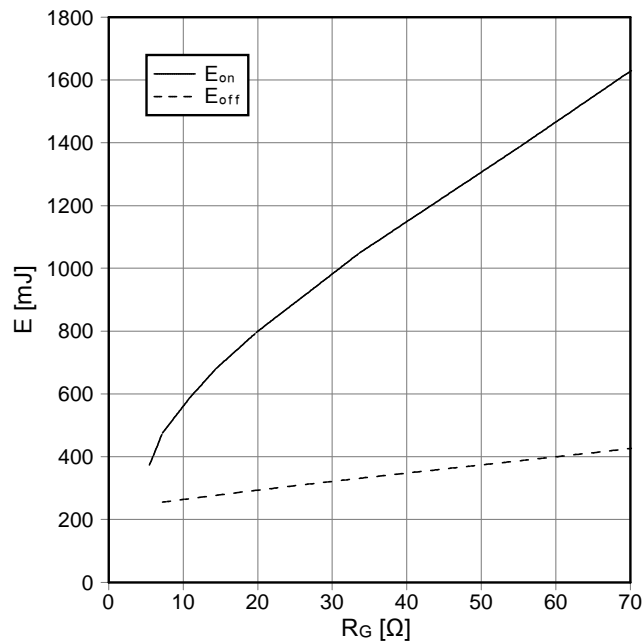

Transienter Wärmewiderstand IGBT-Wechselr.
transient thermal impedance IGBT-inverter

$Z_{thJC} = f(t)$

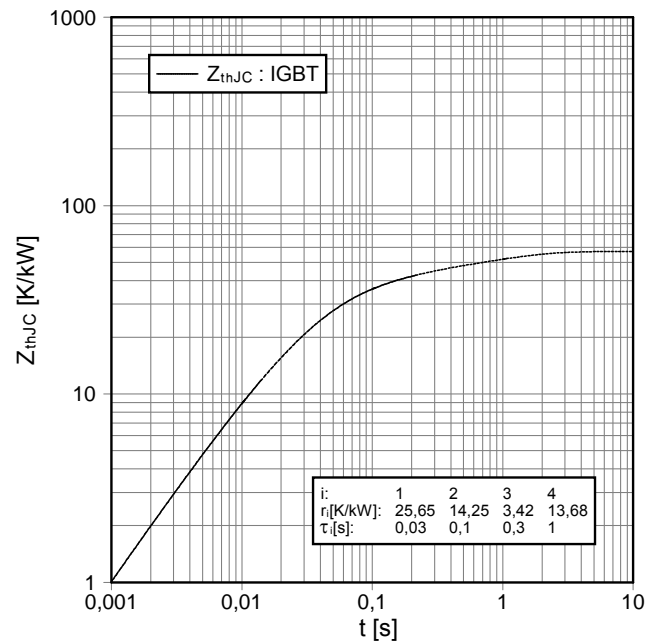

i:	1	2	3	4
r_i [K/KW]:	25,65	14,25	3,42	13,68
τ_i [s]:	0,03	0,1	0,3	1

Sicherer Rückwärts-Arbeitsbereich IGBT-Wr. (RBSOA)
reverse bias safe operating area IGBT-inv. (RBSOA)

$I_C = f(V_{CE})$
 $V_{GE} = \pm 15\text{ V}$, $R_{Goff} = 7,5\ \Omega$, $T_{vj} = 125^\circ\text{C}$, $C_{GE} = 33\text{ nF}$

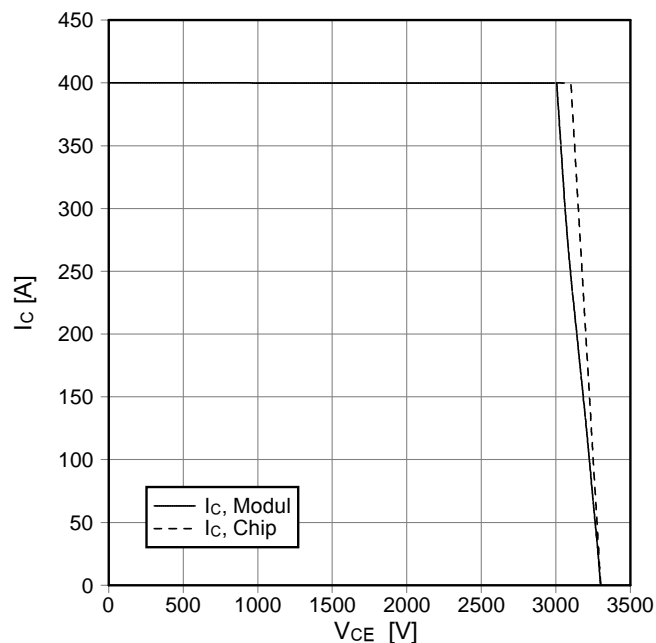

Durchlaßkennlinie der Diode-Wechselr. (typisch)
forward characteristic of diode-inverter (typical)

$I_F = f(V_F)$

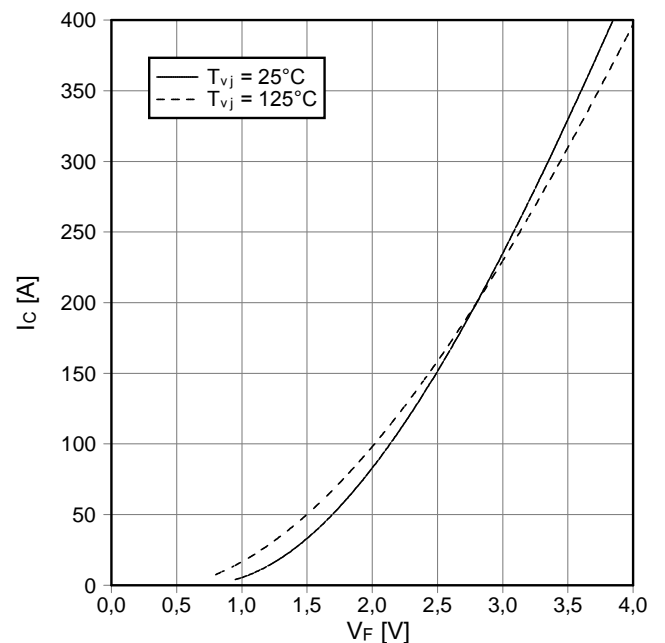

prepared by: Jürgen Biermann	date of publication: 2003-6-12
approved by: Christoph Lübke	revision: 2.0

Vorläufige Daten
preliminary data

Schaltverluste Diode-Wechselr. (typisch)
switching losses diode-inverter (typical)

$E_{rec} = f(I_F)$
 $R_{Gon} = 5,6 \Omega$, $V_{CE} = 1800 V$, $T_{vj} = 125^\circ C$

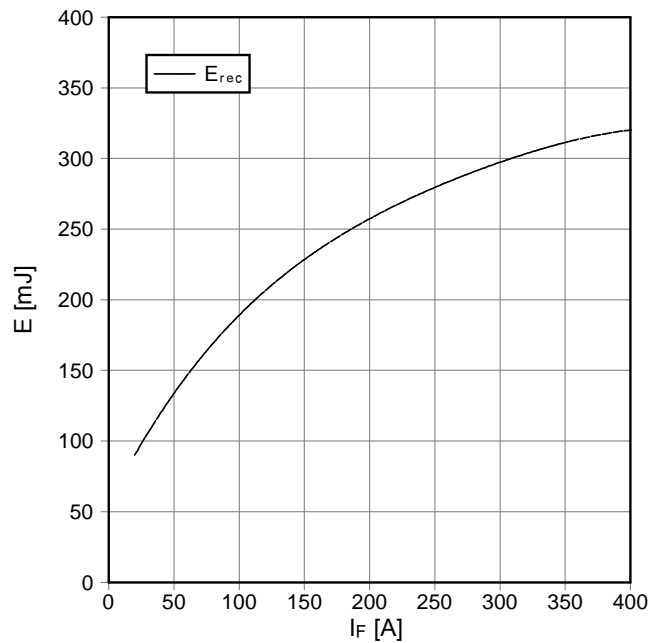

Schaltverluste Diode-Wechselr. (typisch)
switching losses diode-inverter (typical)

$E_{rec} = f(R_G)$
 $I_F = 200 A$, $V_{CE} = 1800 V$, $T_{vj} = 125^\circ C$

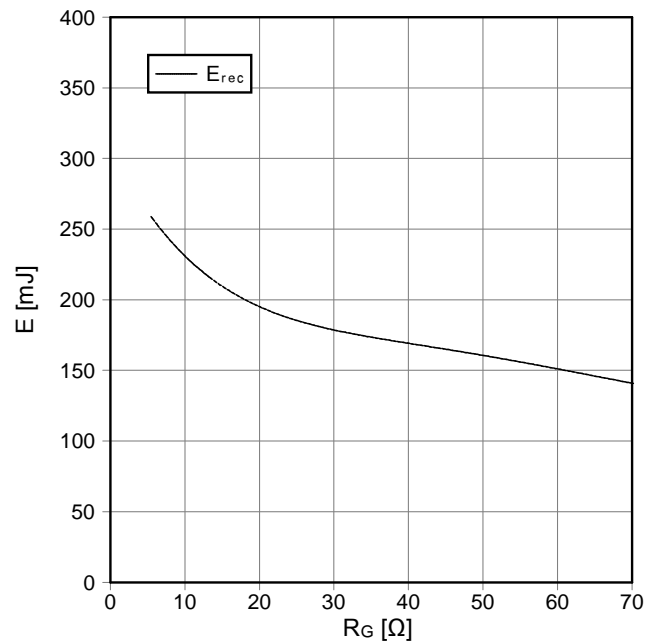

Transienter Wärmewiderstand Diode-Wechselr.
transient thermal impedance diode-inverter

$Z_{thJC} = f(t)$

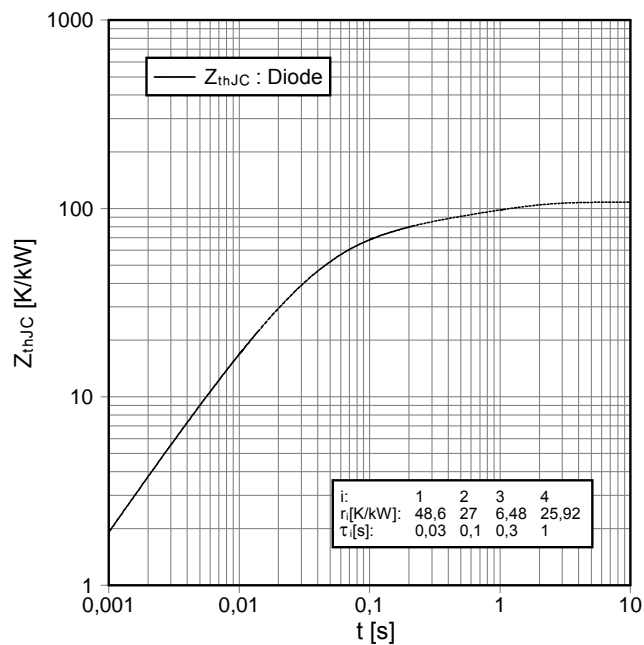

i:	1	2	3	4
r_i [K/kW]:	48,6	27	6,48	25,92
τ [s]:	0,03	0,1	0,3	1

Sicherer Arbeitsbereich Diode-Wechselr. (SOA)
save operation area diode-inverter (SOA)

$I_R = f(V_R)$
 $T_{vj} = 125^\circ C$

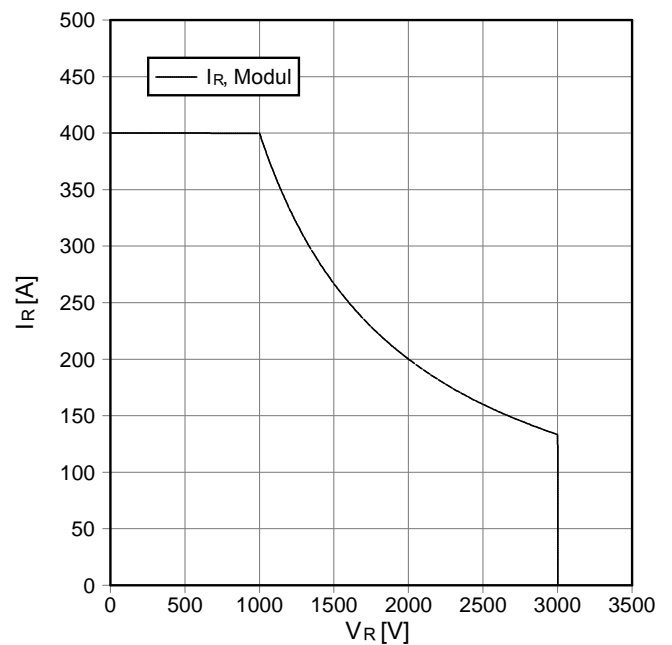

prepared by: Jürgen Biermann	date of publication: 2003-6-12
approved by: Christoph Lübke	revision: 2.0

Vorläufige Daten
preliminary data

Schaltplan/circuit diagram

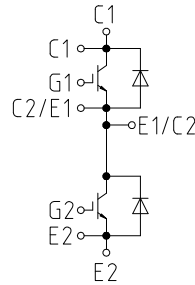

Gehäuseabmessungen/package outlines

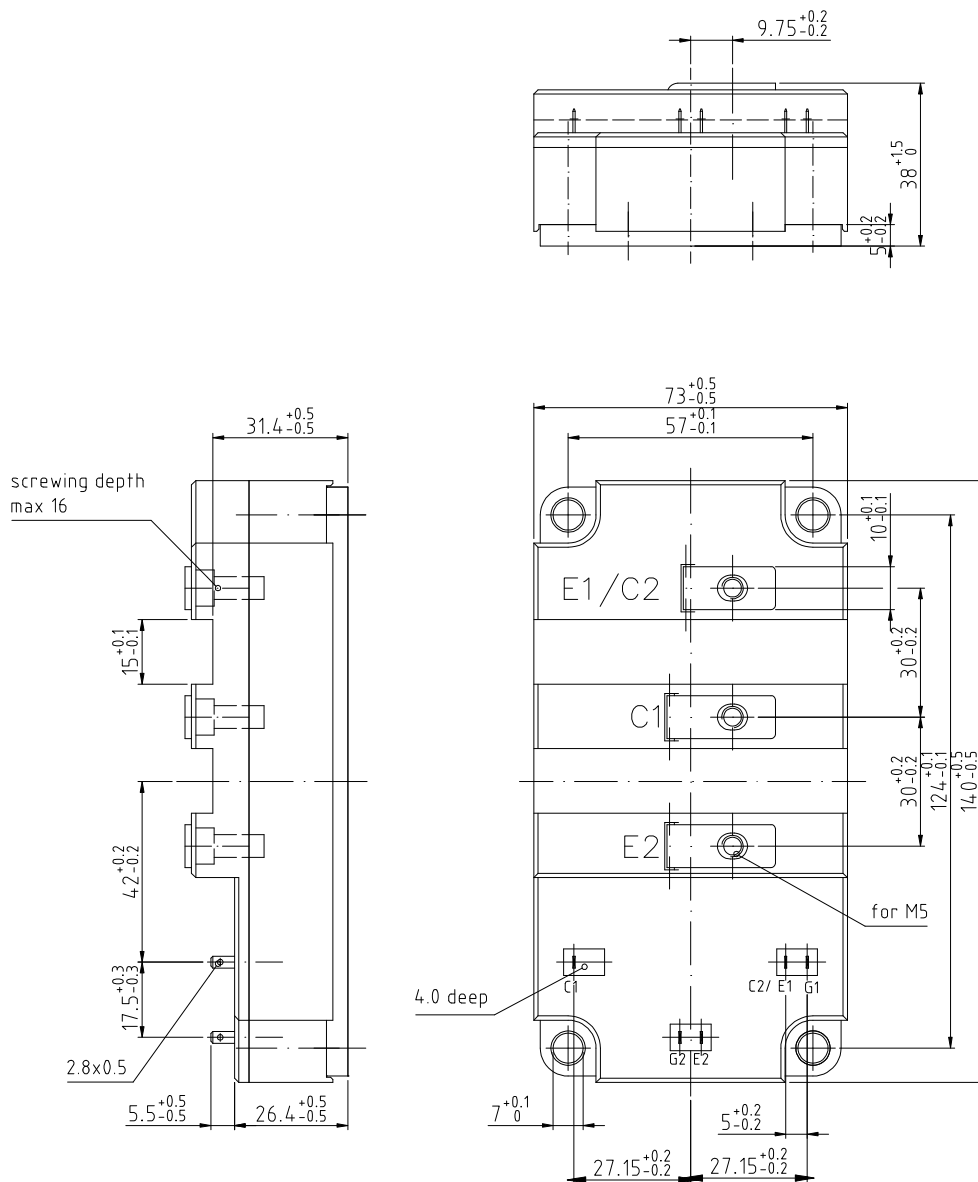

prepared by: Jürgen Biermann
approved by: Christoph Lübke

date of publication: 2003-6-12
revision: 2.0

Terms & Conditions of Usage

Attention

The present product data is exclusively subscribed to technically experienced staff. This Data Sheet is describing the specification of the products for which a warranty is granted exclusively pursuant the terms and conditions of the supply agreement. There will be no guarantee of any kind for the product and its specifications. Changes to the Data Sheet are reserved.

You and your technical departments will have to evaluate the suitability of the product for the intended application and the completeness of the product data with respect to such application. Should you require product information in excess of the data given in the Data Sheet, please contact your local Sales Office via "www.eupec.com / sales & contact".

Warning

Due to technical requirements the products may contain dangerous substances. For information on the types in question please contact your local Sales Office via "www.eupec.com / sales & contact".