

## SEMIPACK® 3 Rectifier Diode Modules

**SKKD 201**    **SKKE 201**  
**SKKD 260**    **SKKE 260**  
**SKMD 260**<sup>1)</sup>

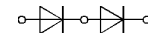

**SKKD**



**SKKE**

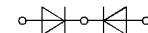

**SKMD**

### Features

- Heat transfer through aluminium nitride ceramic isolated metal baseplate
- Precious metal pressure contacts
- **SKKD** half bridge connection  
**SKMD** center-tap connection common cathode
- UL recognized, file no. E 63 532

### Typical Applications

- Non-controllable rectifiers for AC/AC converters
- Line rectifiers for transistorized AC motor controllers
- Field supply for DC motors
- **SKKE**: Free-wheeling diodes

V <sub>RSM</sub>	V <sub>RRM</sub>	I <sub>FRMS</sub> (maximum values for continuous operation)			
		315 A	410 A	315 A	410 A
V	V	I <sub>FAV</sub> (sin. 180; T <sub>case</sub> = 85 °C)			
		200 A	260 A	200 A	260 A
900	800	<b>SKKD 201/08</b>	<b>SKKD 260/08</b>	<b>SKKE 201/08</b>	–
1300	1200	<b>SKKD 201/12</b>	<b>SKKD 260/12</b>	<b>SKKE 201/12</b>	<b>SKKE 260/12</b>
1500	1400	<b>SKKD 201/14</b>	<b>SKKD 260/14</b>	<b>SKKE 201/14</b>	<b>SKKE 260/14</b>
1700	1600	<b>SKKD 201/16</b>	<b>SKKD 260/16</b>	<b>SKKE 201/16</b>	<b>SKKE 260/16</b>
2100	2000	<b>SKKD 201/20</b>	<b>SKKD 260/20</b>	<b>SKKE 201/20</b>	<b>SKKE 260/20</b>
2300	2200	<b>SKKD 201/22</b>	<b>SKKD 260/22</b>	<b>SKKE 201/22</b>	<b>SKKE 260/22</b>

Symbol	Conditions	SKKD 201 SKKE 201	SKKD 260 SKKE 260	Units	
I <sub>FAV</sub> I <sub>D</sub> <sup>1)</sup>	sin. 180; T <sub>case</sub> = 85 °C B2/B6 T <sub>amb</sub> = 35 °C; P 3/180 F P 16/200 F	200 250/295 385/515	260 280/320 490/655	A A A	
I <sub>FSM</sub> i <sup>2</sup> t	T <sub>vj</sub> = 25 °C; 10 ms T <sub>vj</sub> = 130 °C; 10 ms T <sub>vj</sub> = 25 °C; 8,3 ... 10 ms T <sub>vj</sub> = 130 °C; 8,3 ... 10 ms	6 000 5 000 180 000 125 000	11 000 10 000 605 000 500 000	A A A <sup>2</sup> s A <sup>2</sup> s	
I <sub>RD</sub>	T <sub>vj</sub> max.; V <sub>RD</sub> = V <sub>RRM</sub>	9	15	mA	
V <sub>F</sub> V <sub>(TO)</sub> r <sub>T</sub>	T <sub>vj</sub> = 25 °C (I <sub>F</sub> = . . .); max. T <sub>vj</sub> = 130 °C T <sub>vj</sub> = 130 °C	1,35 (600 A) 0,80 0,8	1,25 (750 A) 0,90 0,37	V V mΩ	
R <sub>thjc</sub> R <sub>thch</sub> T <sub>vj</sub> T <sub>stg</sub>	} per diode/per module <sup>2)</sup>	0,19/0,10 0,06/0,03 – 40 ... +130 – 40 ... +130	0,14/0,07 0,04/0,02 – 40 ... +130 – 40 ... +130	°C/W °C/W °C °C	
V <sub>isol</sub> M <sub>1</sub> M <sub>2</sub> a w		a. c. 50 Hz; r.m.s.; 1 s/1 min to heatsink to terminals approx.	SI units US units SI units US units	3600/3000 5 ± 15 % <sup>3)</sup> 44 ± 15 % <sup>3)</sup> 9 ± 15 % <sup>4)</sup> 80 ± 15 % <sup>4)</sup> 5 · 9,81 800	V~ Nm lb.in. Nm lb.in. m/s <sup>2</sup> g
Case		→ page B 1 – 74	SKKD 201 SKKE 201	A 16 A 17	
		→ page B 1 – 80	SKKD 260 SKKE 260 SKMD 260		A 27 A 28 A 58

<sup>1)</sup> SKMD 260 available on request

<sup>2)</sup> SKKD types only

<sup>3)</sup> See the assembly instructions

<sup>4)</sup> The screws must e lubricated

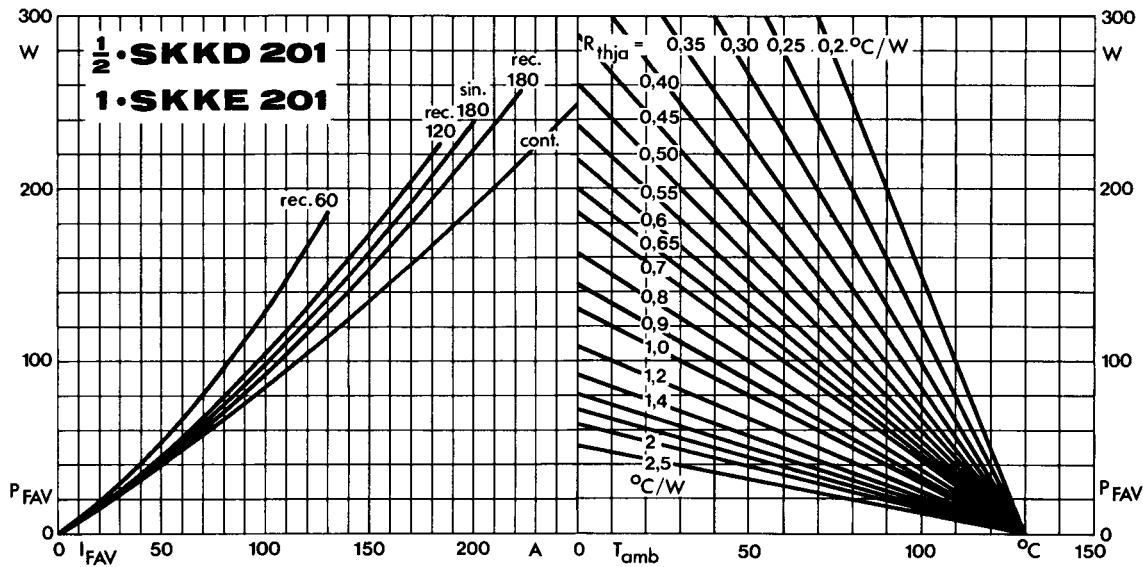

Fig. 11 a Power dissipation per diode vs. forward current and ambient temperature

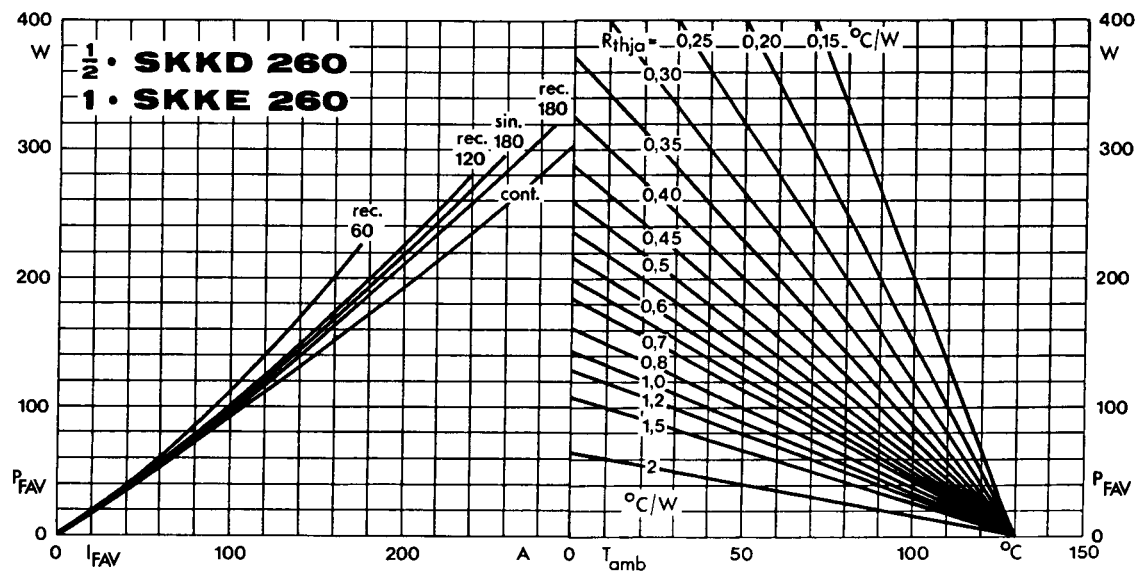

Fig. 11 b Power dissipation per diode vs. forward current and ambient temperature

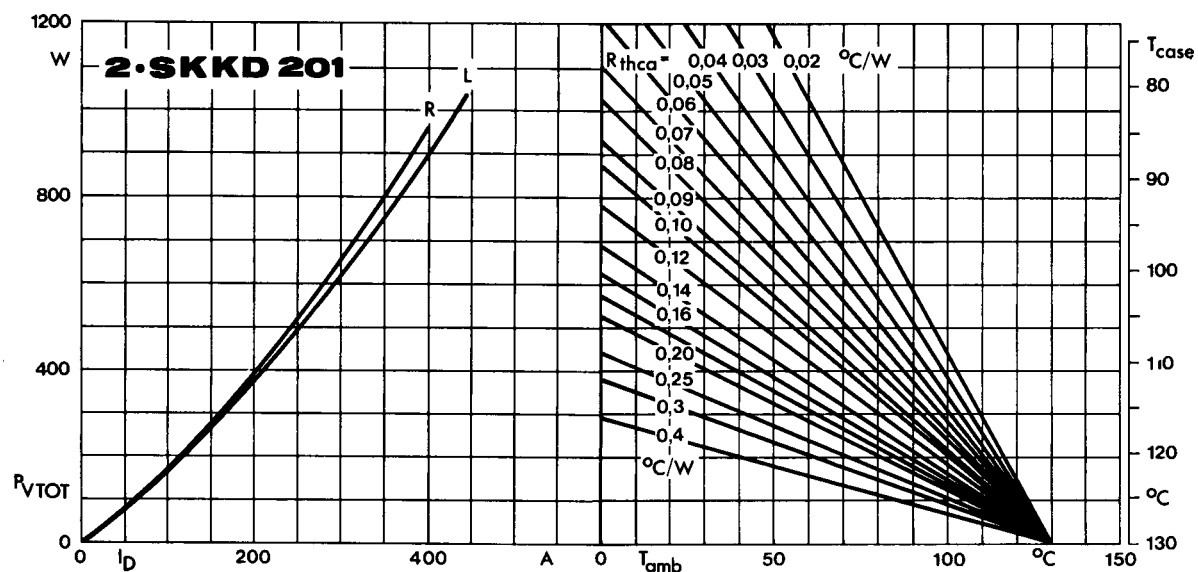

Fig. 12 a Power dissipation of two modules vs. direct current and case temperature

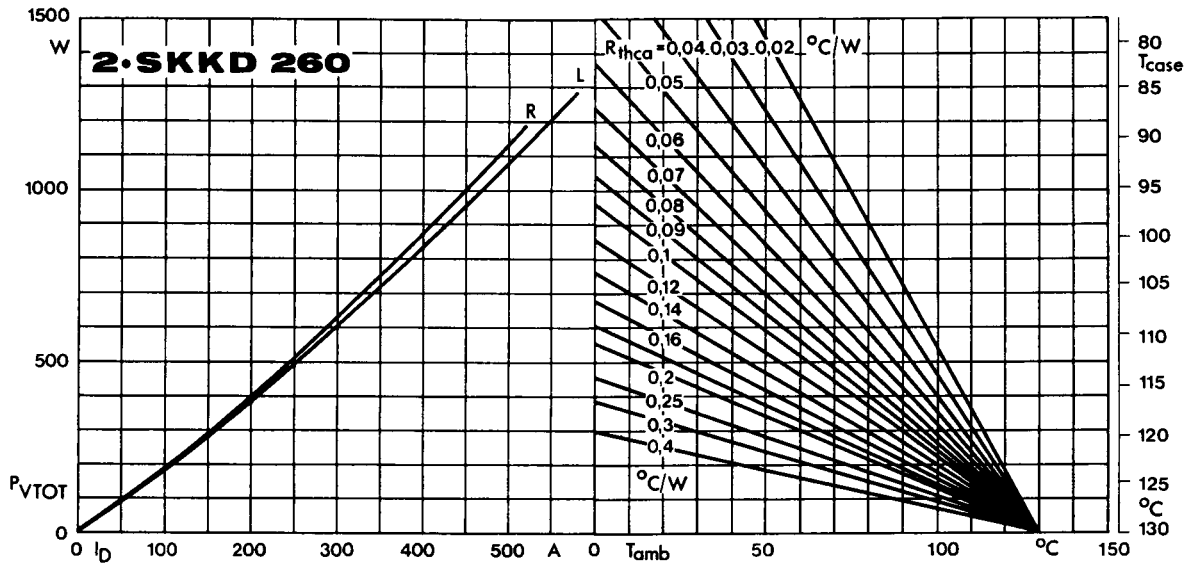

Fig. 12 b Power dissipation of two modules vs. direct current and case temperature

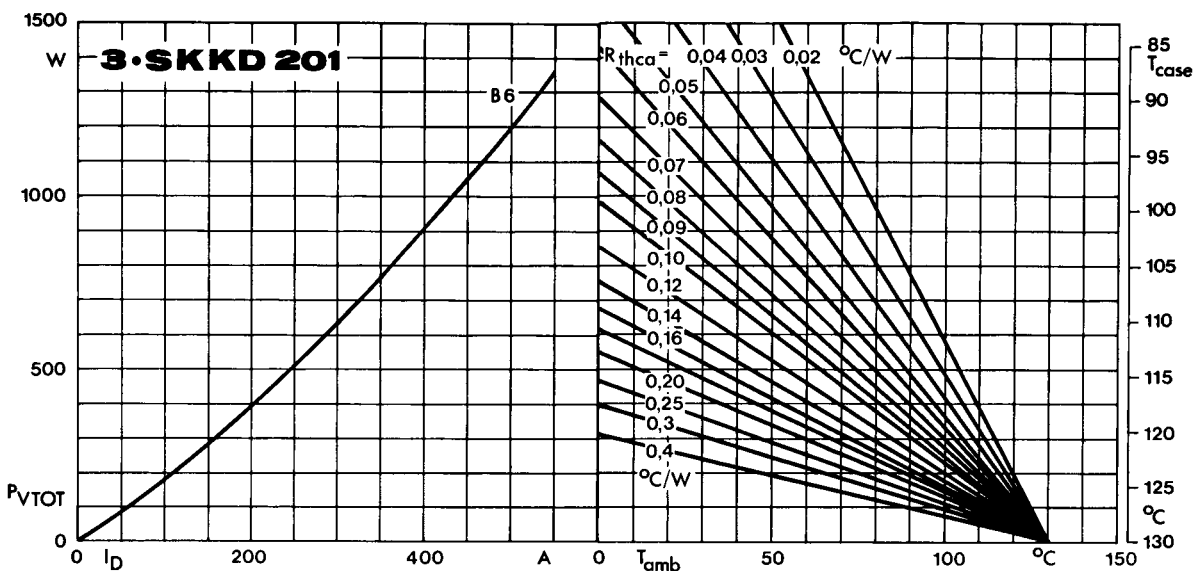

Fig. 13 a Power dissipation of three modules vs. direct current and case temperature

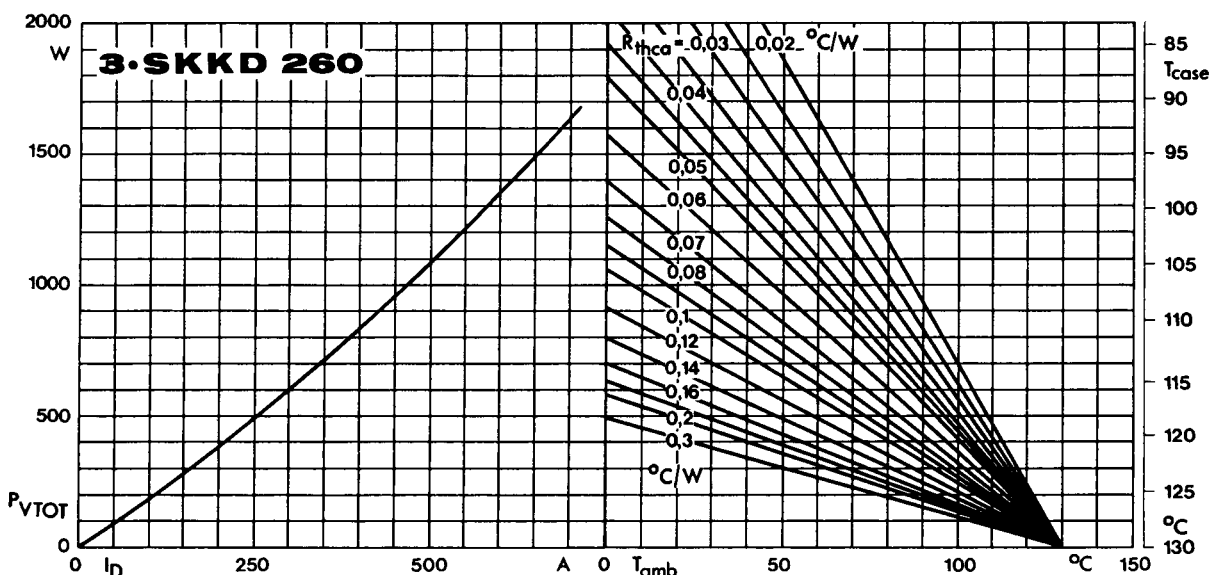

Fig. 13 b Power dissipation of three modules vs. direct current and case temperature

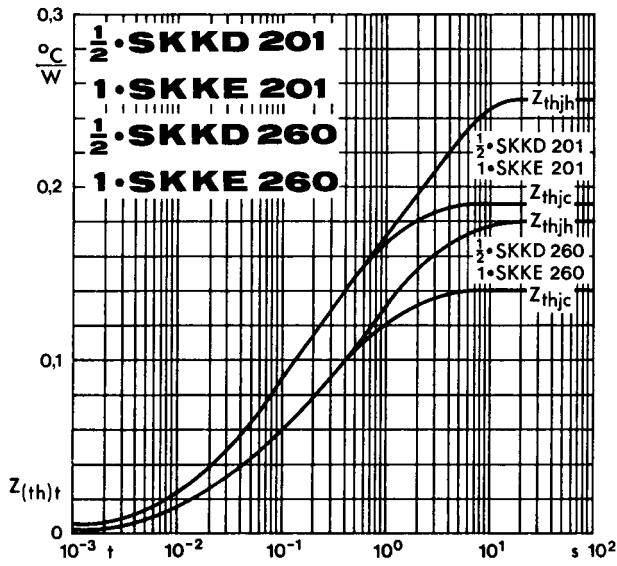

Fig. 14 Transient thermal impedance vs. time

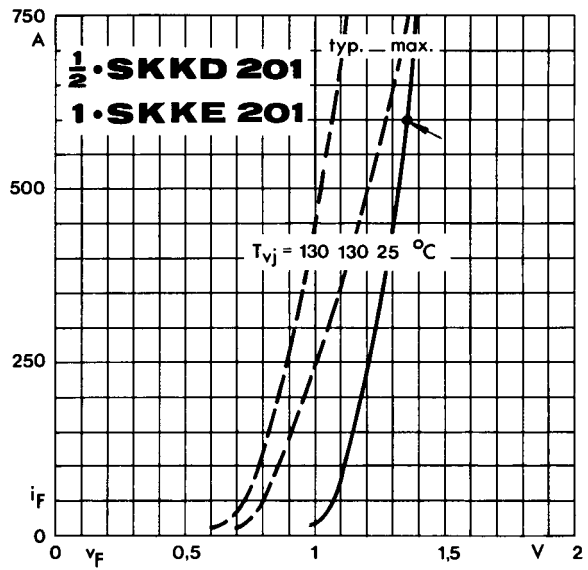

Fig. 15 a Forward characteristics

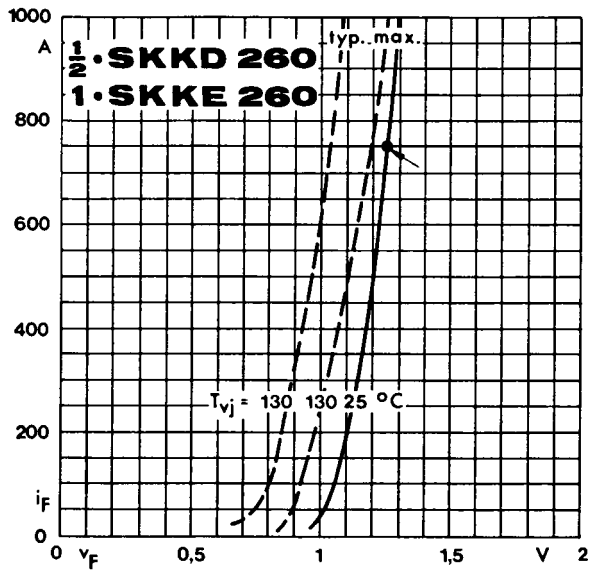

Fig. 15 b Forward characteristics

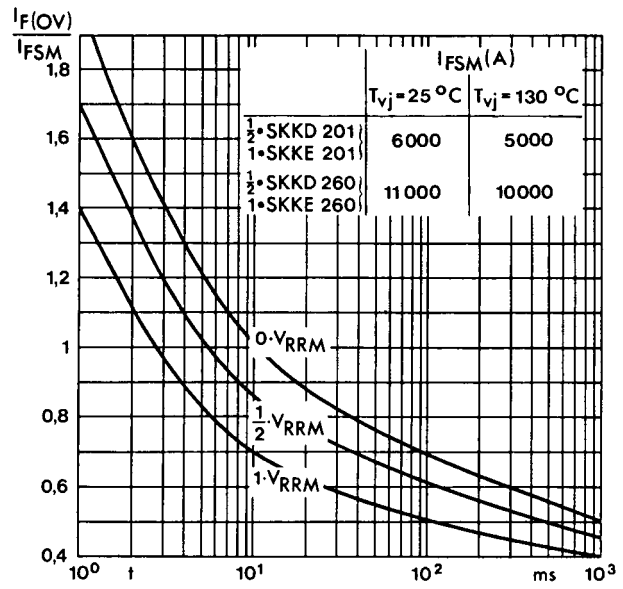
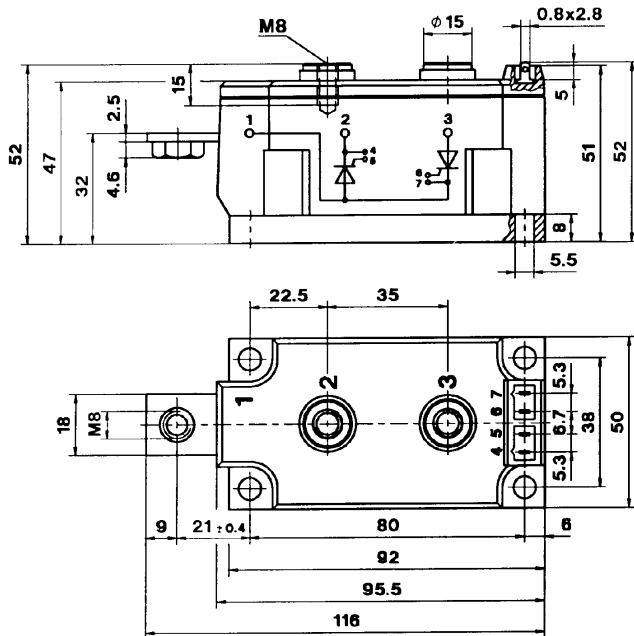

Fig. 16 Surge overload current vs. time

**SKKT 131, SKKT 161**

Case A 13

SEMIPACK 3 UL recognized, file no. E 63 532



**SKKL 131, SKKL 161**

Case A 15

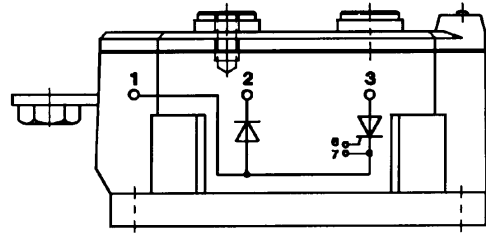

**SKKD 201**

Case A 16

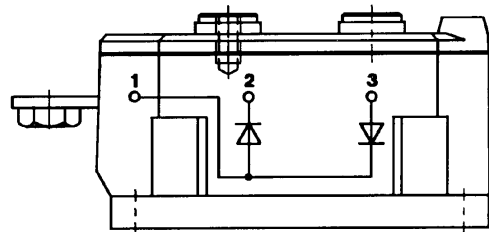

**SKKH 131, SKKH 161**

Case A 14

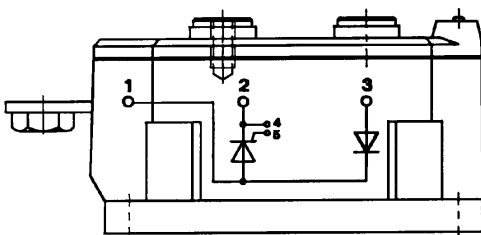

**SKKE 201**

Case A 17

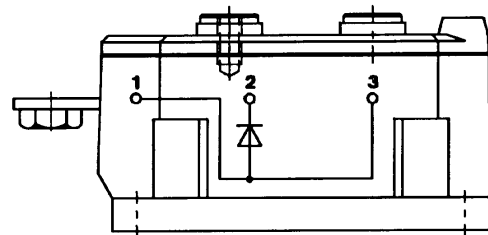

Dimensions in mm

**SKKT 210, SKKT 250**

Case A 25

SEMIPACK 3

UL recognized, file no. E 63 532

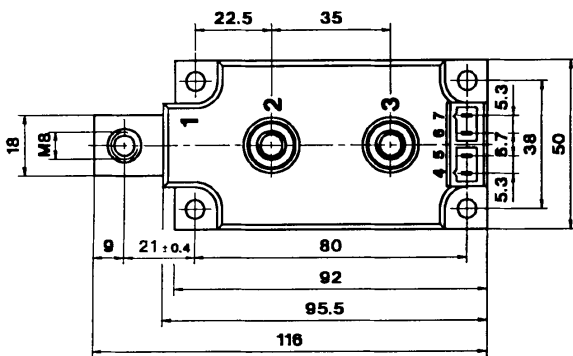
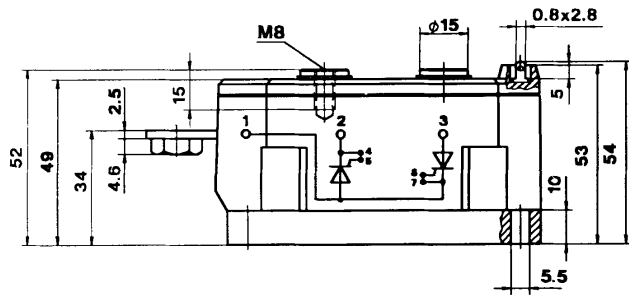

**SKKH 210, SKKH 250**

Case A 26

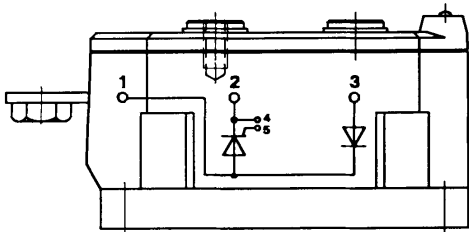

**SKKD 260**

Case A 27

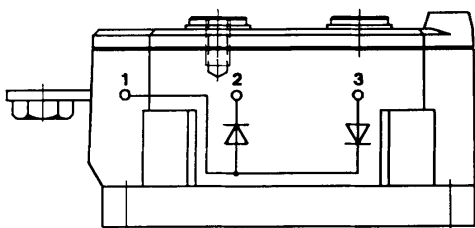

**SKKE 260**

Case A 28

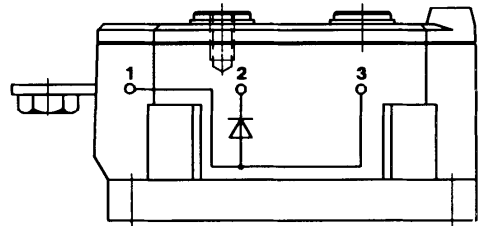

**SKKL 210, SKKL 250**

Case A 35

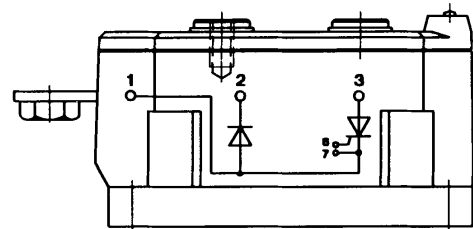

**SKMD 260**

Case A 58

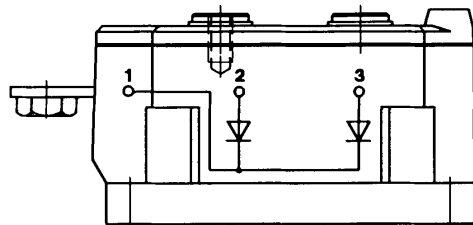

**SKMT 250**

Case A 64

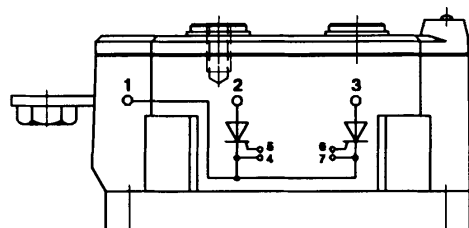

Dimensions in mm

**This datasheet has been downloaded from:**

**[www.EEworld.com.cn](http://www.EEworld.com.cn)**

**Free Download**

**Daily Updated Database**

**100% Free Datasheet Search Site**

**100% Free IC Replacement Search Site**

**Convenient Electronic Dictionary**

**Fast Search System**

**[www.EEworld.com.cn](http://www.EEworld.com.cn)**