



MMG200S060B6N

600V 200A IGBT Module

RoHS Compliant

JULY 2010

PRELIMINARY

FEATURES

- Ultra Low Loss
- High Ruggedness
- High Short Circuit Capability
- Positive Temperature Coefficient
- Integrated Gate Resistor

APPLICATIONS

- Invector
- Converter
- Welder
- SMPS and UPS
- Induction Heating



GS Series Module

ABSOLUTE MAXIMUM RATINGS

$T_C=25^{\circ}\text{C}$ unless otherwise specified

Symbol	Parameter	Test Conditions	Values	Unit
IGBT				
V_{CES}	Collector - Emitter Voltage		600	V
V_{GES}	Gate - Emitter Voltage		± 20	V
I_C	DC Collector Current	$T_C=25^{\circ}\text{C}$	230	A
		$T_C=50^{\circ}\text{C}$	200	A
I_{Cpuls}	Pulsed Collector Current	$T_C=25^{\circ}\text{C}, t_p=1\text{ms}$	460	A
		$T_C=50^{\circ}\text{C}, t_p=1\text{ms}$	400	A
P_{tot}	Power Dissipation Per IGBT		735	W
T_J	Junction Temperature Range		-40 to +150	$^{\circ}\text{C}$
T_{STG}	Storage Temperature Range		-40 to +125	$^{\circ}\text{C}$
V_{isol}	Insulation Test Voltage	AC, $t=1\text{min}$	3000	V
Free-Wheeling Diode				
V_{RRM}	Repetitive Reverse Voltage		600	V
$I_{F(AV)}$	Average Forward Current	$T_C=25^{\circ}\text{C}$	200	A
		$T_C=50^{\circ}\text{C}$	160	A
$I_{F(RMS)}$	RMS Forward Current		285	A
I_{FSM}	Non-Repetitive Surge Forward Current	$T_J=45^{\circ}\text{C}, t=10\text{ms}, \text{Sine}$	600	A
		$T_J=45^{\circ}\text{C}, t=8.3\text{ms}, \text{Sine}$	660	A

MacMic Science & Technology Co., Ltd.

Add: #18, Hua Shan Zhong Lu, New District, Changzhou City, Jiangsu Province, P. R .of China

Tel.: +86-519-85163708 Fax: +86-519-85162291 Post Code: 213022 Website: www.macmicst.com

MMG200S060B6N

ELECTRICAL CHARACTERISTICS

$T_C=25^\circ\text{C}$ unless otherwise specified

Symbol	Parameter	Test Conditions	Min.	Typ.	Max.	Unit
IGBT						
$V_{GE(th)}$	Gate - Emitter Threshold Voltage	$V_{CE}=V_{GE}, I_C=4\text{mA}$	4.5	5.5	6.5	V
$V_{CE(sat)}$	Collector - Emitter Saturation Voltage	$I_C=200\text{A}, V_{GE}=15\text{V}, T_J=25^\circ\text{C}$		1.95	2.45	V
		$I_C=200\text{A}, V_{GE}=15\text{V}, T_J=125^\circ\text{C}$		2.2		V
I_{CES}	Collector Leakage Current	$V_{CE}=600\text{V}, V_{GE}=0\text{V}, T_J=25^\circ\text{C}$			0.5	mA
		$V_{CE}=600\text{V}, V_{GE}=0\text{V}, T_J=125^\circ\text{C}$		1		mA
I_{GES}	Gate Leakage Current	$V_{CE}=0\text{V}, V_{GE}=\pm 20\text{V}$	-0.6		0.6	μA
R_{Gint}	Integrated Gate Resistor			5	7	Ω
Q_{ge}	Gate Charge	$V_{CC}=300\text{V}, I_C=200\text{A}, V_{GE}=\pm 15\text{V}$		890		nC
C_{ies}	Input Capacitance	$V_{CE}=25\text{V}, V_{GE}=0\text{V}, f=1\text{MHz}$		9		nF
C_{oes}	Output Capacitance			0.9		nF
C_{res}	Reverse Transfer Capacitance			0.8		nF
$t_{d(on)}$	Turn - on Delay Time	$V_{CC}=300\text{V}, I_C=200\text{A}$		163		ns
t_r	Rise Time	$R_G = 1.5 \Omega, V_{GE}=\pm 15\text{V}$		43		ns
$t_{d(off)}$	Turn - off Delay Time	$T_J=25^\circ\text{C}$		253		ns
t_f	Fall Time	Inductive Load		33		ns
$t_{d(on)}$	Turn - on Delay Time	$V_{CC}=300\text{V}, I_C=200\text{A}$		180		ns
t_r	Rise Time	$R_G = 1.5 \Omega, V_{GE}=\pm 15\text{V}$		49		ns
$t_{d(off)}$	Turn - off Delay Time	$T_J=125^\circ\text{C}$		285		ns
t_f	Fall Time	Inductive Load		41		ns
E_{on}	Turn - on Switching Energy	$V_{CC}=300\text{V}, I_C=200\text{A}$ $T_J=25^\circ\text{C}$		3		mJ
		$R_G = 1.5 \Omega$ $T_J=125^\circ\text{C}$		4.6		mJ
E_{off}	Turn - off Switching Energy	$V_{GE}=\pm 15\text{V}$ $T_J=25^\circ\text{C}$		4.1		mJ
		Inductive Load $T_J=125^\circ\text{C}$		6.3		mJ
Free-Wheeling Diode						
V_F	Forward Voltage	$I_F=200\text{A}, V_{GE}=0\text{V}, T_J=25^\circ\text{C}$		1.25	1.6	V
		$I_F=200\text{A}, V_{GE}=0\text{V}, T_J=125^\circ\text{C}$		1.2		V
t_{rr}	Reverse Recovery Time	$I_F=200\text{A}, V_R=300\text{V}$		249		ns
I_{RRM}	Max. Reverse Recovery Current	$di_F/dt=-1000\text{A}/\mu\text{s}$		107		A
Q_{rr}	Reverse Recovery Charge	$T_J=125^\circ\text{C}$		15.5		μC

THERMAL AND MECHANICAL CHARACTERISTICS

Symbol	Parameter	Test Conditions	Min.	Typ.	Max.	Unit
R_{thJC}	Junction-to-Case Thermal Resistance	Per IGBT			0.17	K/W
R_{thJD}	Junction-to-Case Thermal Resistance	Per Inverse Diode			0.3	K/W
Torque	Module-to-Sink	Recommended (M6)	3		5	N · m
Torque	Module Electrodes	Recommended (M5)	2.5		5	N · m
Weight				150		g

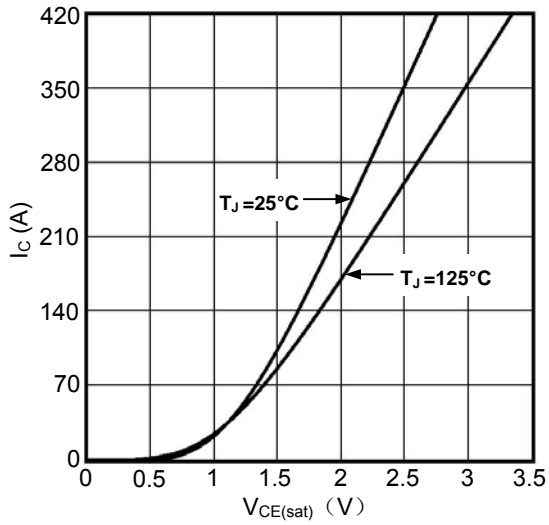

Figure1. Typical Output characteristics

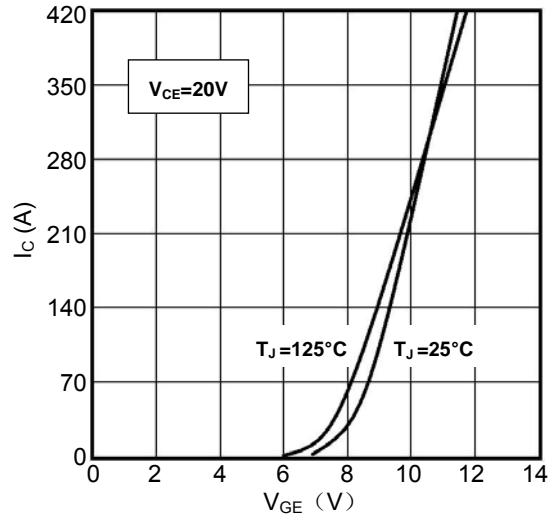

Figure2. Typical Transfer characteristics

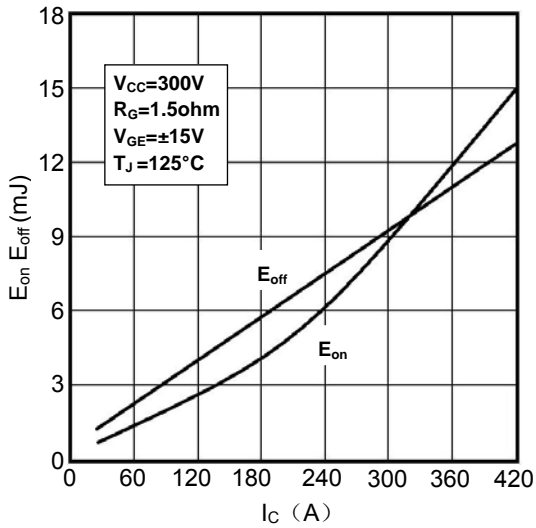

Figure3. Switching Energy vs. Collector Current

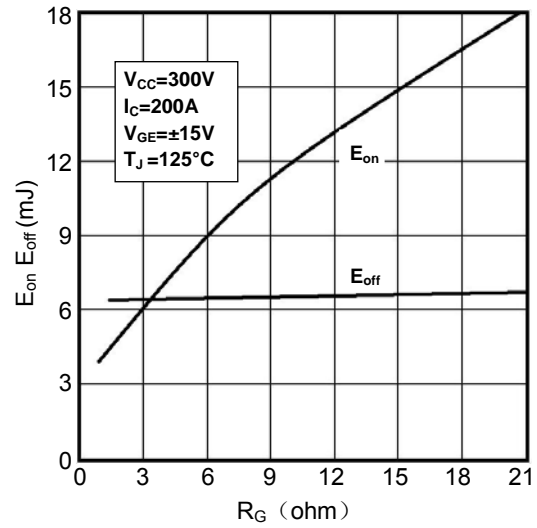

Figure4. Switching Energy vs. Gate Resistor

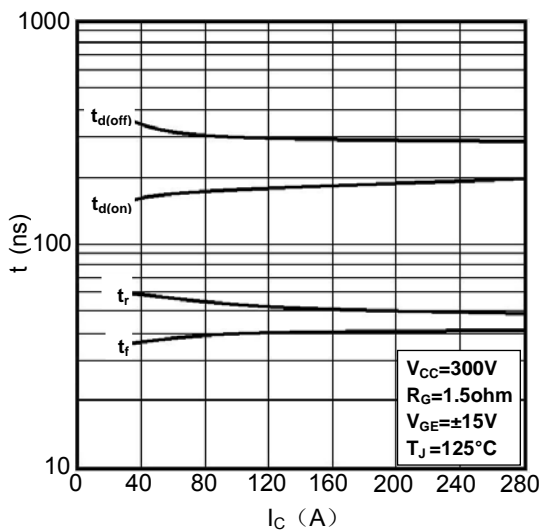

Figure5. Switching Times vs. Collector Current

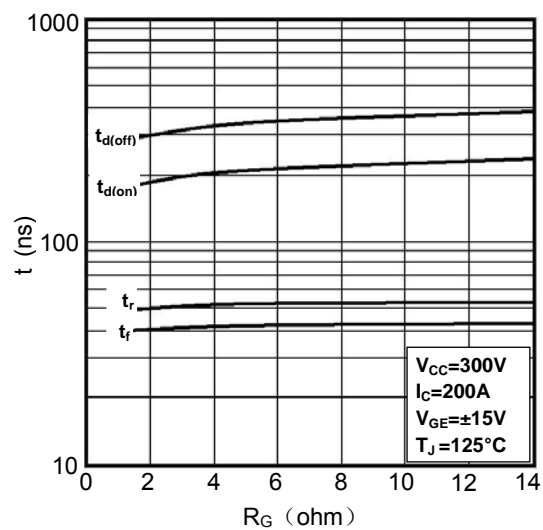

Figure6. Switching Times vs. Gate Resistor

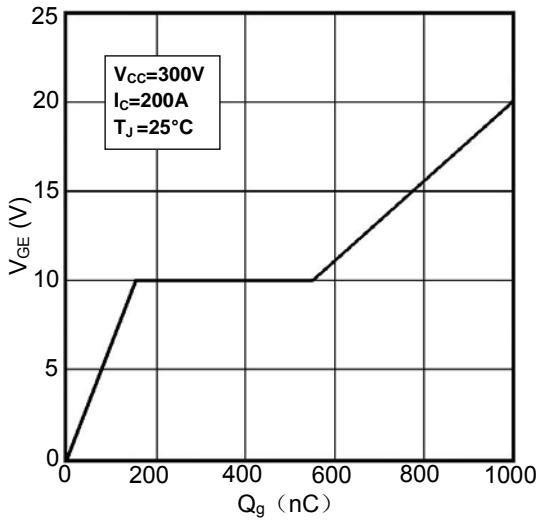

Figure7. Gate Charge characteristics

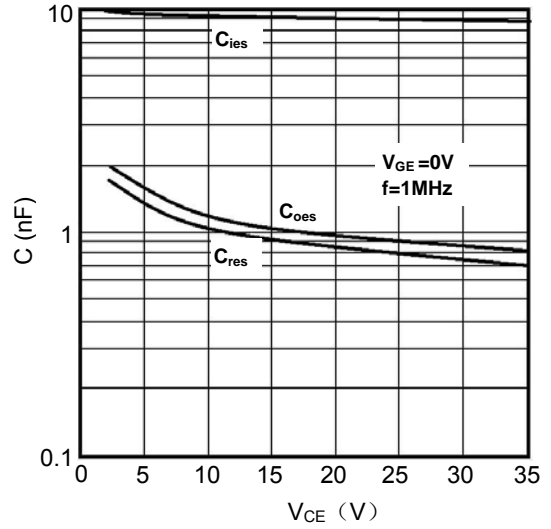

Figure8. Typical Capacitances vs. V_{CE}

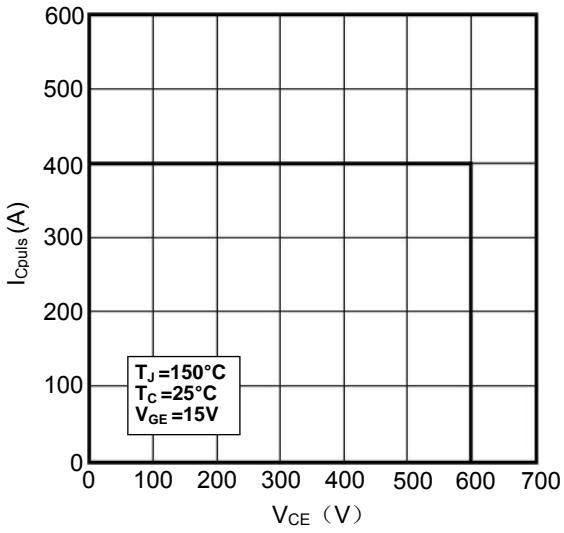

Figure9. Reverse Biased Safe Operating Area

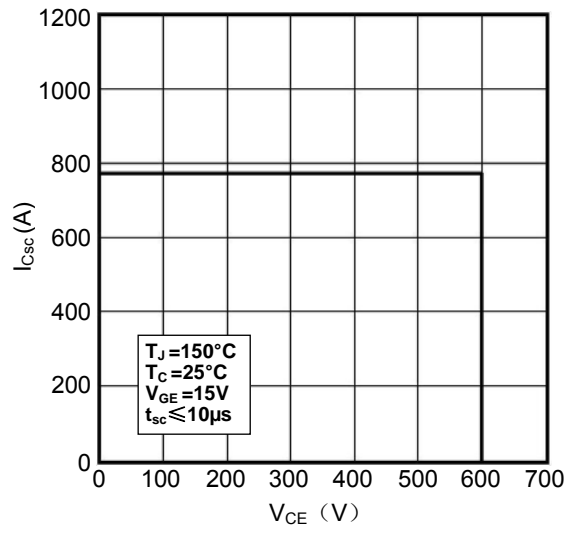

Figure10. Short Circuit Safe Operating Area

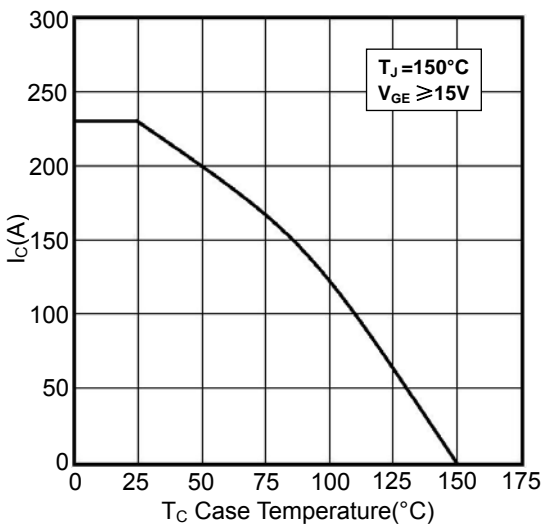

Figure11. Rated Current vs. T_C

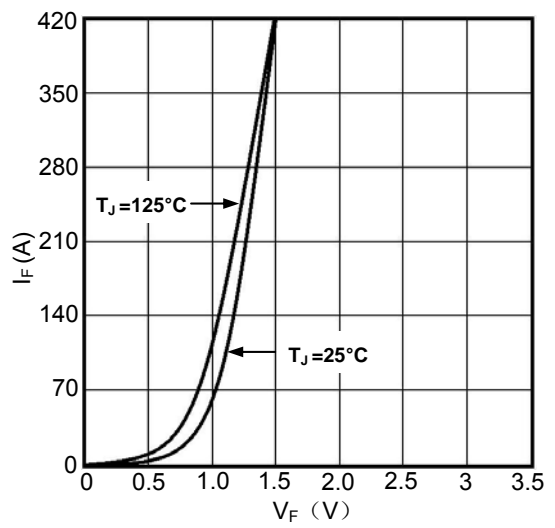
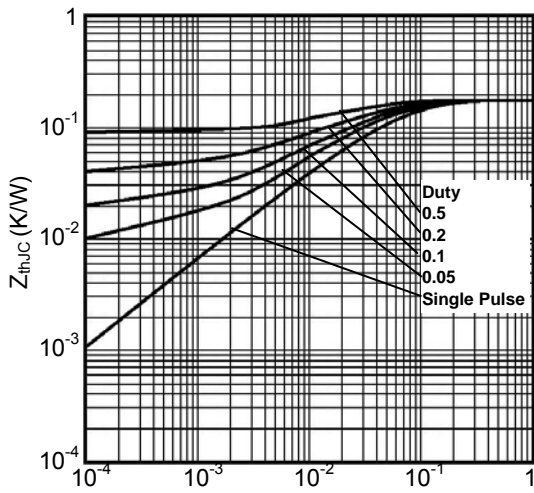
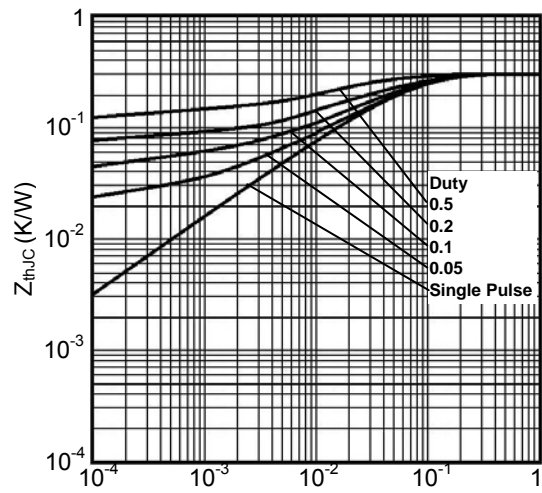

Figure12. Diode Forward Characteristics



Rectangular Pulse Duration (seconds)
Figure13. Transient Thermal Impedance of IGBT



Rectangular Pulse Duration (seconds)
Figure14. Transient Thermal Impedance of Diode

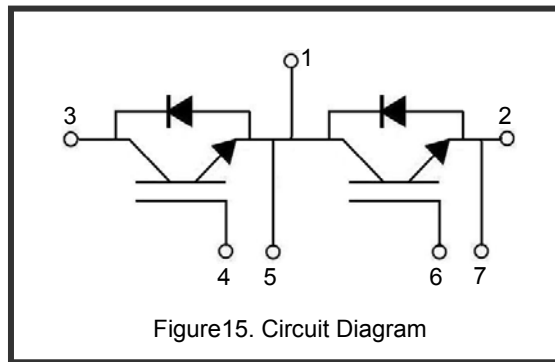
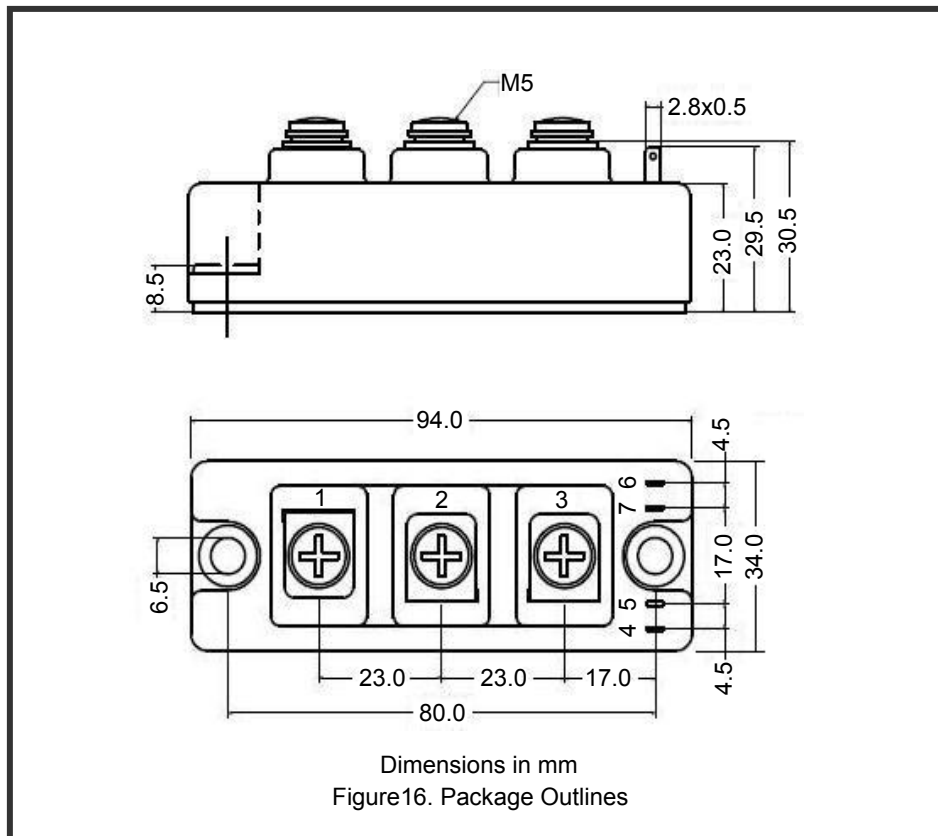

Figure15. Circuit Diagram



Dimensions in mm
Figure16. Package Outlines