

Features

- Isolation voltage 3500 V~
- Industrial Standard Package
- High Surge Capability
- Glass Passivated Chips
- Simple Mounting
- Electrically Isolated by DBC Ceramic



Applications

- DC Motor Control and Drives
- Battery Charges
- Welders
- Power Converters
- Lighting Control
- Heat and Temperature Control

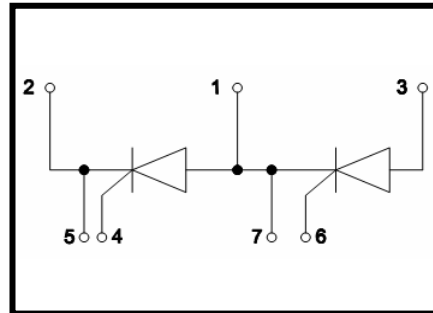

Advantages

- Space and weight savings
- Improved temperature and power cycling

ABSOLUTE MAXIMUM RATINGS

 $T_C=25^{\circ}\text{C}$ unless otherwise specified

Symbol	Test Condition	Value	Unit
V_{RRM}		1600	V
$I_{T(AV)}$	$T_C=85^{\circ}\text{C}$, 180° conduction, half sine wave;	130	A
$I_{T(RMS)}$	as AC switch;	300	A
I_{TSM}	$T_J=45^{\circ}\text{C}$, $t=10\text{ms}$ (50Hz), sine, $V_R=0$;	3200	A
	$T_J=45^{\circ}\text{C}$, $t=8.3\text{ms}$ (60Hz), sine, $V_R=0$;	3360	
	$T_J=45^{\circ}\text{C}$, $t=10\text{ms}$ (50Hz), sine, $V_R=V_{RRM}$;	2700	
	$T_J=45^{\circ}\text{C}$, $t=8.3\text{ms}$ (60Hz), sine, $V_R=V_{RRM}$;	2800	
I^2t	$T_J=45^{\circ}\text{C}$, $t=10\text{ms}$ (50Hz), sine, $V_R=0$;	52	$\text{K A}^2\text{s}$
	$T_J=45^{\circ}\text{C}$, $t=8.3\text{ms}$ (60Hz), sine, $V_R=0$;	57	
	$T_J=45^{\circ}\text{C}$, $t=10\text{ms}$ (50Hz), sine, $V_R=V_{RRM}$;	37	
	$T_J=45^{\circ}\text{C}$, $t=8.3\text{ms}$ (60Hz), sine, $V_R=V_{RRM}$;	39	
I_{DRM}/I_{RRM}	$T_J=125^{\circ}\text{C}$, $V_D=V_R=1600\text{V}$;	50	mA
dV/dt	$T_J=125^{\circ}\text{C}$, exponential to 67% rated V_{DRM}	1000	V/us
V_{ISOL}	50Hz, all terminals shorted, $t=1\text{s}$, $I_{ISOL}\leq 1\text{mA}$;	3500	V~
T_J	Max. junction operating temperature range	-40~125	$^{\circ}\text{C}$
T_{STG}	Max. storage temperature range	-40~150	$^{\circ}\text{C}$

ELECTRICAL CHARACTERISTICS $T_C=25^{\circ}\text{C}$ unless otherwise specified

Symbol	Test Condition	Min.	Typ.	Max.	Unit
V_{TO}	$16.7\% \times I_T \times I_{AV} < I < I_T \times I_{AV}, T_J = 130^{\circ}\text{C};$			0.86	V
	$I > I_T \times I_{AV}, T_J = 130^{\circ}\text{C};$			1.05	V
r_t	$16.7\% \times I_T \times I_{AV} < I < I_T \times I_{AV}, T_J = 130^{\circ}\text{C};$			2.02	m Ω
	$I > I_T \times I_{AV}, T_J = 130^{\circ}\text{C};$			1.65	m Ω
I_H	$V_{AK} = 6\text{V}, \text{initial } I_T = 30\text{A};$			200	mA
I_L	Anode supply =6V, resistive load=1 Ω , gate pulse =10V, 100us;			400	mA
V_{TM}	$I_{TM} = 408\text{A}, t_d = 10 \text{ms}, \text{half sine};$		1.57		V
P_{GM}	$t_p \leq 5\text{ms}, T_J = 125^{\circ}\text{C};$			12	W
$P_{GM(AV)}$	$f = 50\text{Hz}, T_J = 125^{\circ}\text{C};$			3	W
I_{GM}	$t_p \leq 5\text{ms}, T_J = 125^{\circ}\text{C};$			3	A
$-V_{GT}$				10	V
V_{GT}	$V_A = 6\text{V}, R_A = 1\Omega, T_J = -40^{\circ}\text{C};$			4	V
	$V_A = 6\text{V}, R_A = 1\Omega;$			2.5	
	$V_A = 6\text{V}, R_A = 1\Omega, T_J = 125^{\circ}\text{C};$			1.7	
I_{GT}	$V_A = 6\text{V}, R_A = 1\Omega, T_J = -40^{\circ}\text{C};$			270	A
	$V_A = 6\text{V}, R_A = 1\Omega;$			150	
	$V_A = 6\text{V}, R_A = 1\Omega, T_J = 125^{\circ}\text{C};$			80	
V_{GD}	$V_{AK} = V_{DRM}, T_J = 125^{\circ}\text{C}$			0.3	V
I_{GD}				10	mA
di/dt	$I_{TM} = 400\text{A}, \text{rated } V_{DRM}, T_J = 125^{\circ}\text{C}$			300	A/us

THERMAL AND MECHANICAL CHARACTERISTICS $T_C=25^{\circ}\text{C}$ unless otherwise specified

Symbol	Test Condition	value	Unit
R_{thjc}	DC operation, per junction;	0.20	K/W
R_{THCS}	Mounting surface smooth, flat and greased, per junction;	0.1	K/W
Md	Mounting torque(M6)	4 to 6	N·m
	Terminal connection torque(M6)		
Weight	Typical value	156	g

Characteristic curves

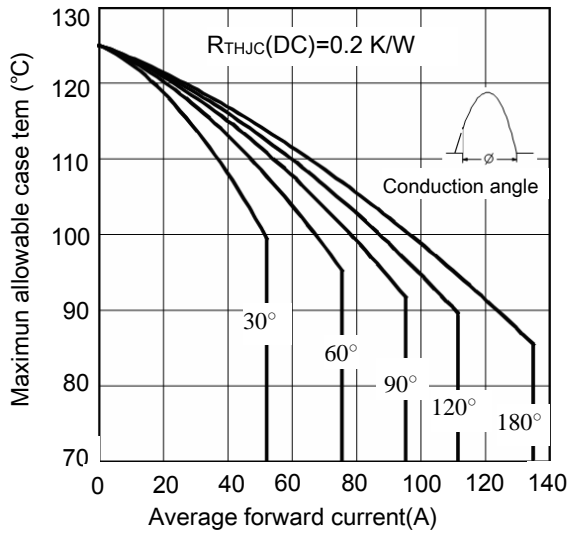

Figure 1. current rating characteristics

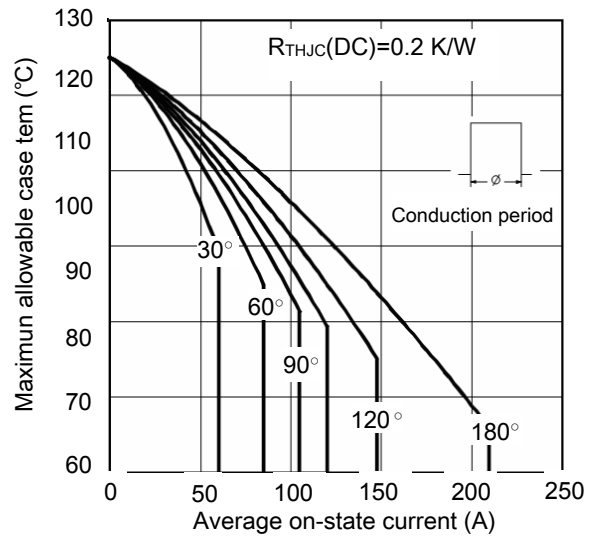

Figure 2. current rating characteristics

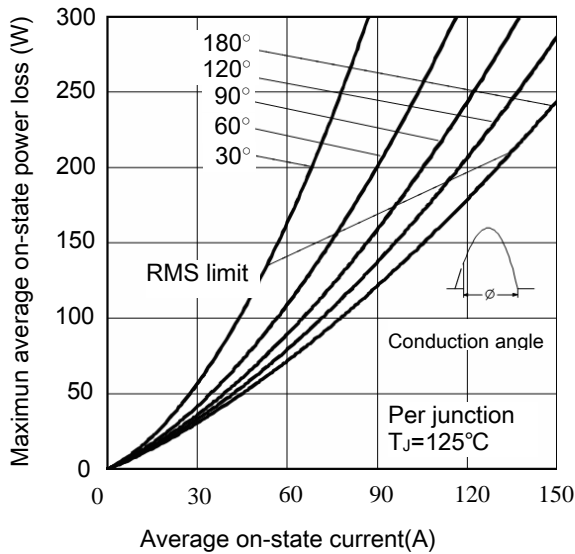

Figure 3. on-state power loss characteristics

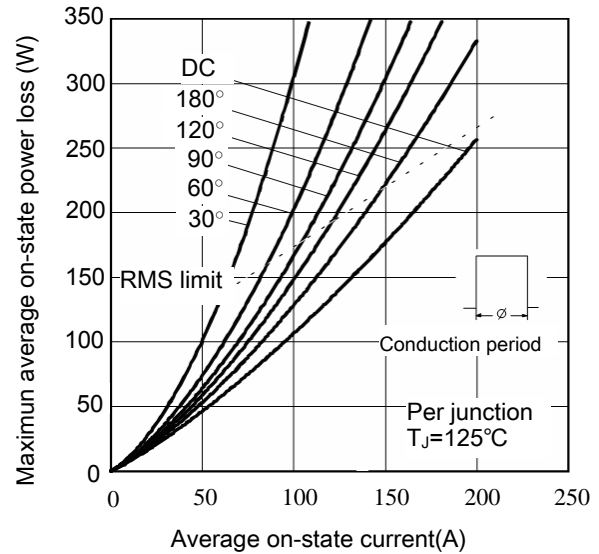

Figure 4. on-state power loss characteristics

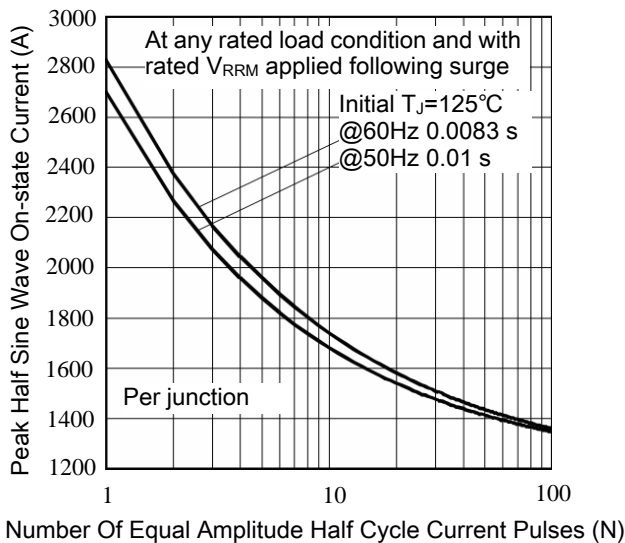

Figure 5. Maximum Non-Repetitive Surge Current

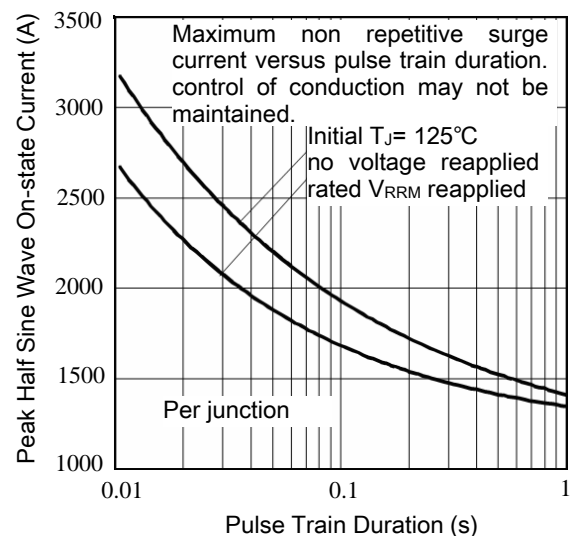

Figure 6. Maximum Non-Repetitive Surge Current

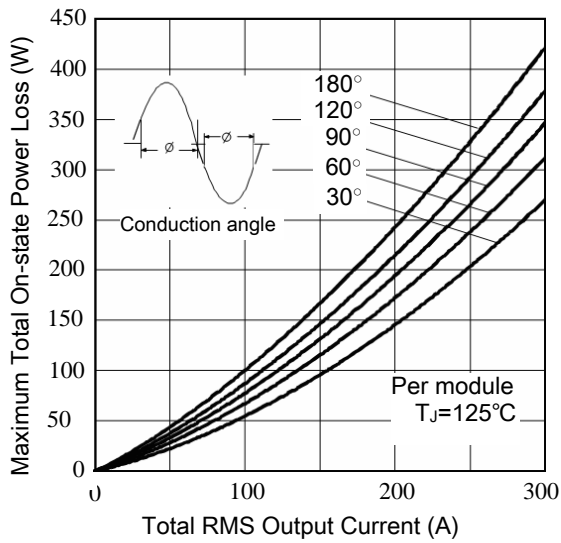

Figure 7. On-State Power Loss Characteristics-1

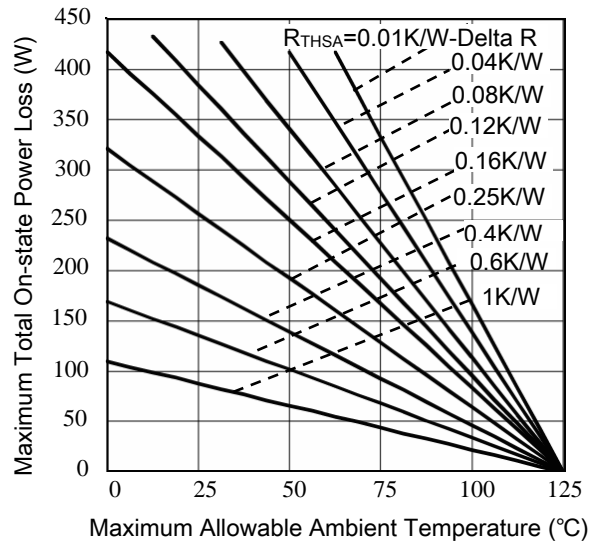

Figure 8 On-State Power Loss Characteristics-2

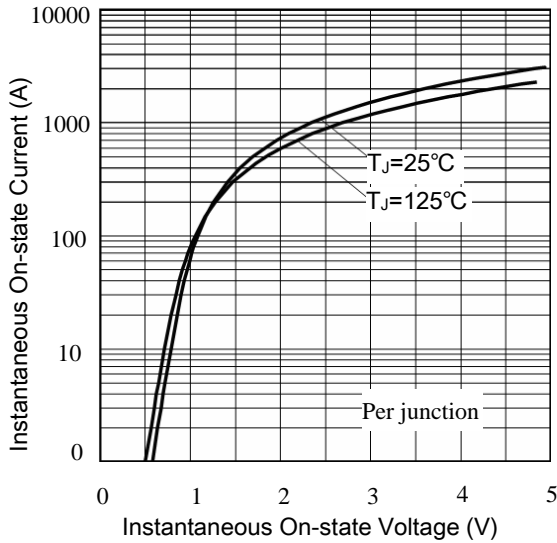

Figure.9 On State Voltage Drop Characteristics

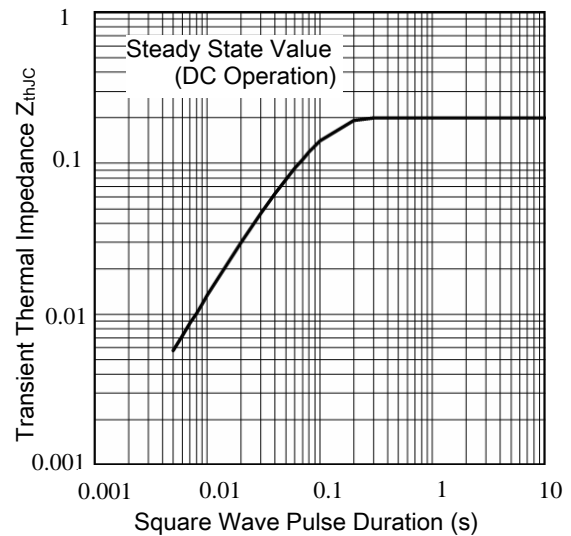

Figure.10 Thermal Impedance ZthJC Characteristics

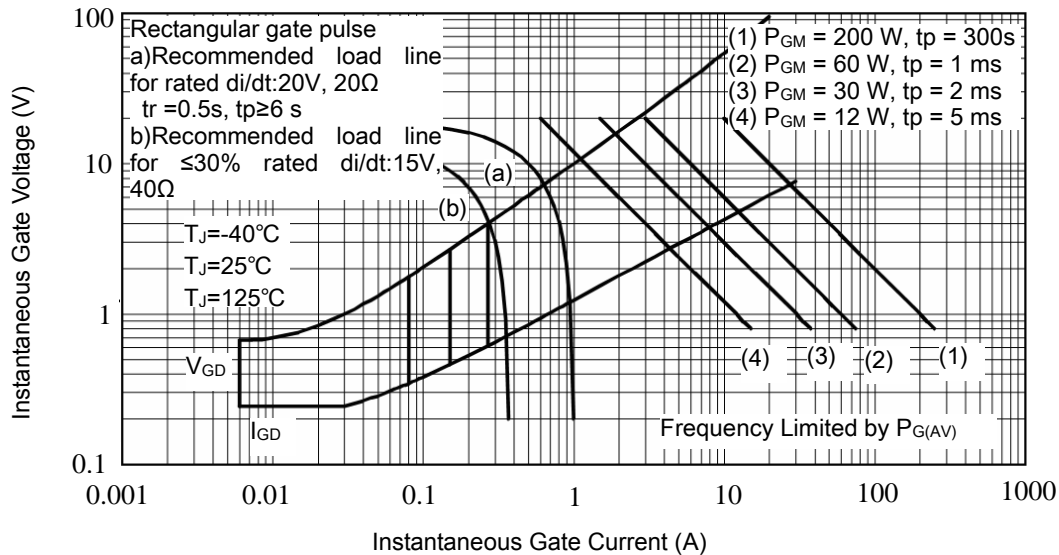

Figure.11 Gate Characteristics

Package Outline (Dimensions in mm)

