

Intelligent Power Module (R-Series)

Maximum Ratings and Characteristics

Absolute Maximum Ratings (T_C=25°C)

Items	Symbols	Ratings		Units
		Min.	Max.	
DC Bus Voltage	V _{DC}	0	450	V
DC Bus Voltage (surge)	V _{DC(Surge)}	0	500	
DC Bus Voltage (short operating)	V _{SC}	200	400	
Collector-Emitter Voltage	V _{CES}	0	600	A
Inverter	I _C		75	
Collector	I _{CP}		150	
Current	-I _C		75	W
Collector Power Dissipation <small>One Transistor</small>	P _C		320	
Voltage of Power Supply for Driver	V _{CC}	0	20	
Input Signal Voltage	V _{IN}	0	V _Z	V
Input Signal Current	I _{IN}		1	
Alarm Signal Voltage	V _{ALM}	0	V _{CC}	
Alarm Signal Current	I _{ALM}		15	mA
Junction Temperature	T _J		150	
Operating Temperature	T _{OP}	-20	100	
Storage Temperature	T _{stg}	-40	125	°C
Isolation Voltage	V _{iso}		2500	
Screw Torque	Mounting *1		3.5	
	Terminals *1		3.5	

Note: *1: Recommendable Value: 2.5 – 3.0 Nm (M5)

Outline Drawing

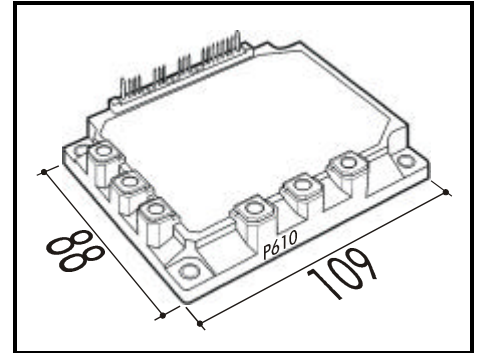

Electrical Characteristics of Power Circuit (at T_J=25°C, V_{CC}=15V)

Items		Symbols	Conditions	Min.	Typ.	Max.	Units
INV	Collector Current At Off Signal Input	I _{CES}	V _{CE} =600V, Input Terminal Open			1.0	mA
	Collector-Emitter Saturation Voltage	V _{CE(Sat)}	I _C =75A			2.8	V
	Forward Voltage of FWD	V _F	-I _C =75A			3.0	V

Electrical Characteristics of Control Circuit (at T_J=25°C, V_{CC}=15V)

Items		Symbols	Conditions	Min.	Typ.	Max.	Units
Current of P-Line Side Driver (One Unit)		I _{CCP}	f _{SW} =0~15kHz, T _C =-20~100°C	3		18	mA
Current of N-Line Side Driver (Three Units)		I _{CCN}	f _{SW} =0~15kHz, T _C =-20~100°C	10		65	
Input Signal Threshold Voltage		V _{IN(th)}	On	1.00	1.35	1.70	V
Input Zener Voltage			Off	1.25	1.60	1.95	
Over Heating Protection Temperature Level		T _{COH}	V _{DC} =0V, I _C =0A, Case Temp.	110		125	°C
Hysteresis		T _{CH}			20		
IGBT Chips Over Heating Protec. Temp. Level		T _{JOH}	Surface of IGBT Chip	150			
Hysteresis		T _{IH}			20		A
Inverter Collector Current Protection Level		I _{OC}	T _J =125°C	113			
Over Current Detecting Time		t _{DOC}	T _J =25°C		10		μs
Alarm Signal Hold Time		t _{ALM}		1.5	2		ms
Limiting Resistor for Alarm		R _{ALM}		1425	1500	1575	Ω
Under Voltage Protection Level		V _{UV}		11.0		12.5	V
Hysteresis		V _H		0.2			

Dynamic Characteristics (at T_C=T_J=125°C, V_{CC}=15V)

Items	Symbols	Conditions	Min.	Typ.	Max.	Units
Switching Time	t _{ON}	I _C =75A, V _{DC} =300V	0.3			μs
	t _{OFF}				3.6	
	t _{RR}	I _F =75A, V _{DC} =300V			0.4	

Thermal Characteristics

Items	Symbols	Conditions	Min.	Typ.	Max.	Units
Thermal Resistance	R _{th(i-c)}	Inverter IGBT			0.39	°C/W
	R _{th(j-c)}	Diode			0.90	
	R _{th(c-f)}	With Thermal Compound		0.05		

■ Equivalent Circuit

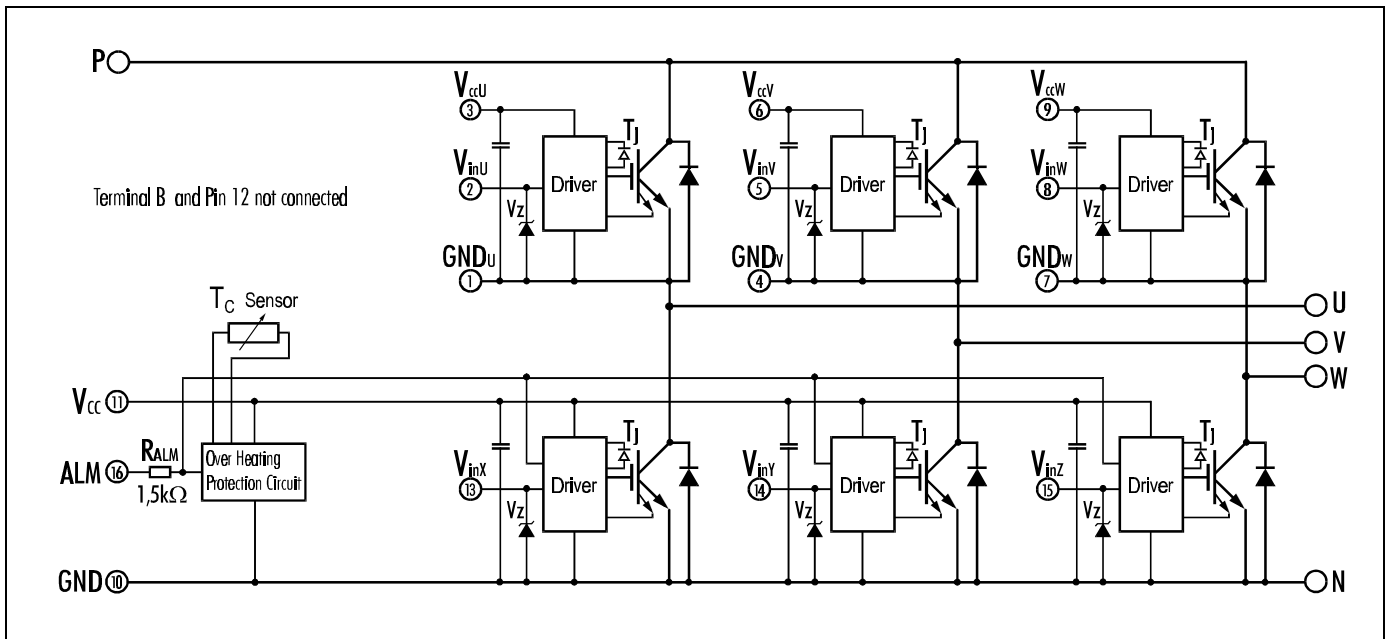

Drivers include following functions

- Short circuit protection circuit
- Amplifier for driver
- Undervoltage protection circuit
- Overcurrent protection circuit
- IGBT Chip overheating protection

Control Circuit

Power Supply Current vs. Switching Frequency

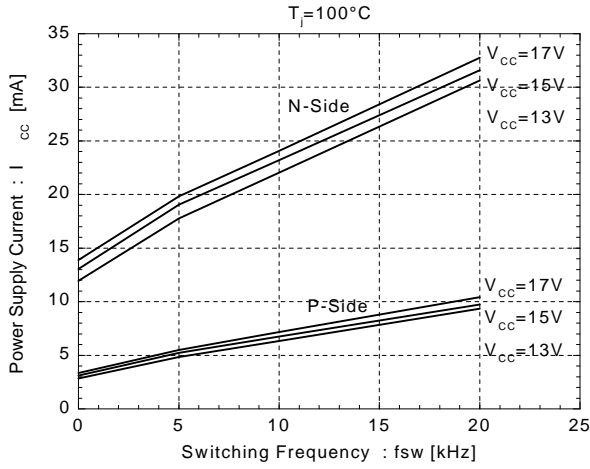

Input Signal Threshold Voltage vs. Power Supply Voltage

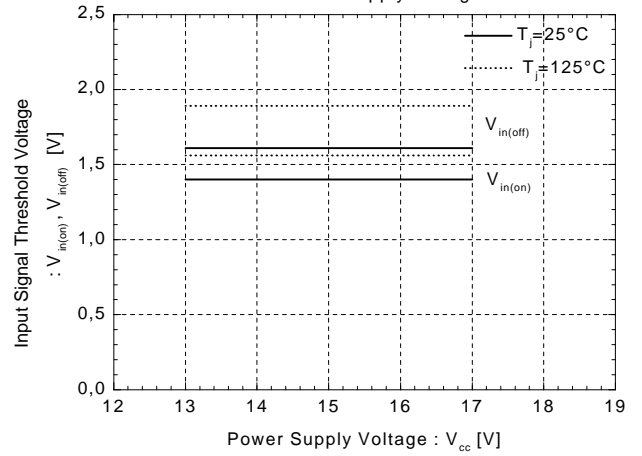

Under Voltage vs. Junction Temperature

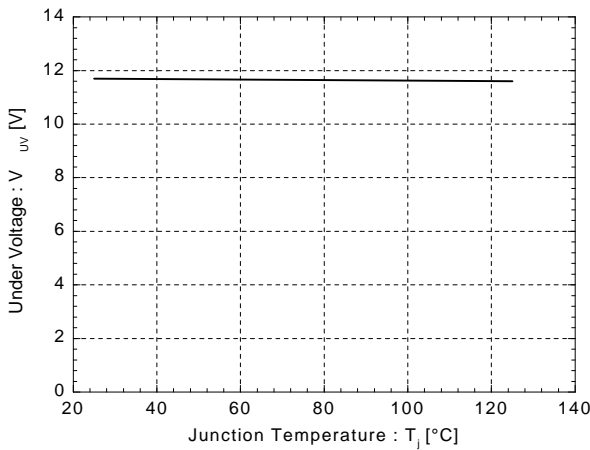

Under Voltage Hysteresis vs. Junction Temperature

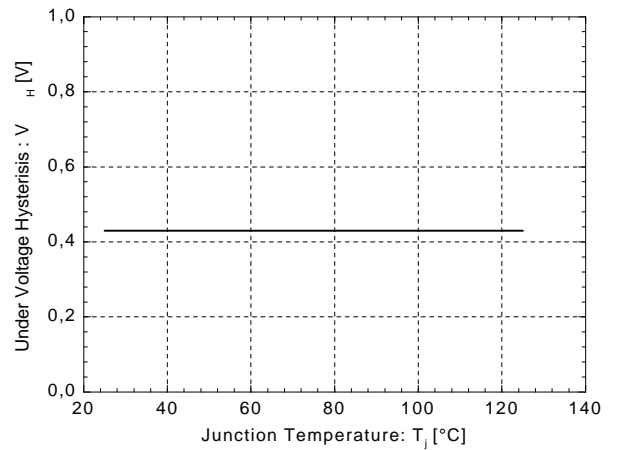

Alarm Hold Time vs. Power Supply Voltage

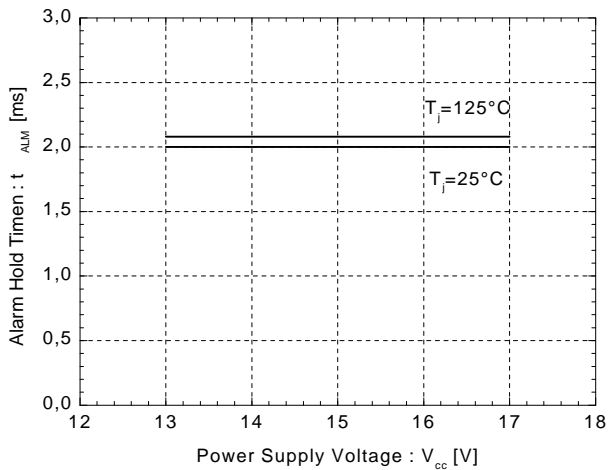

Over Heating Characteristics

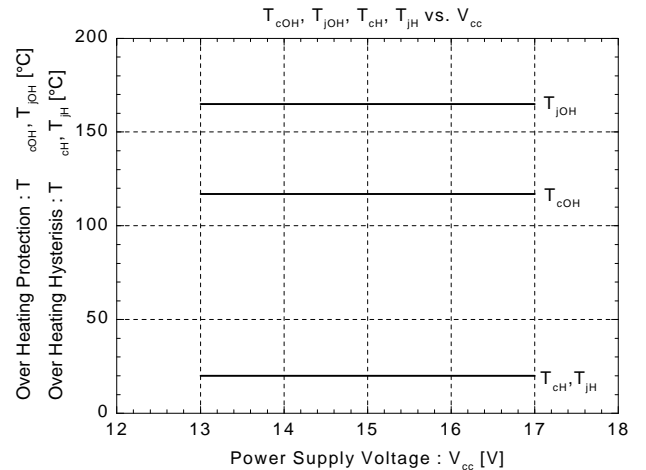

■ Inverter

Collector Current vs. Collector-Emitter Voltage

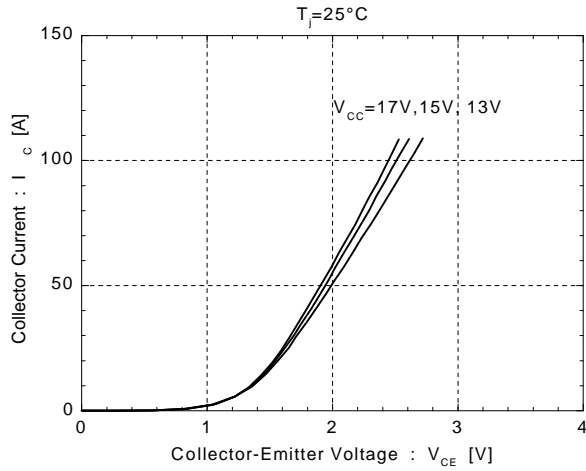

Collector Current vs. Collector-Emitter Voltage

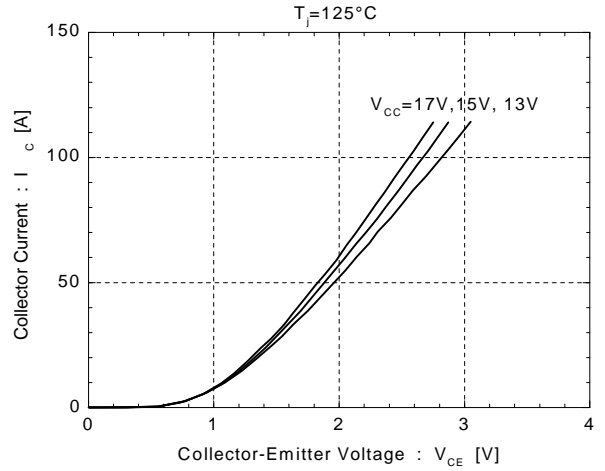

Switching Time vs. Collector Current

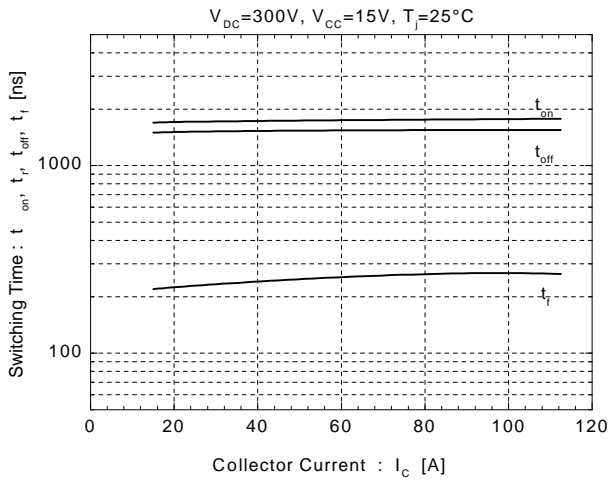

Switching Time vs. Collector Current

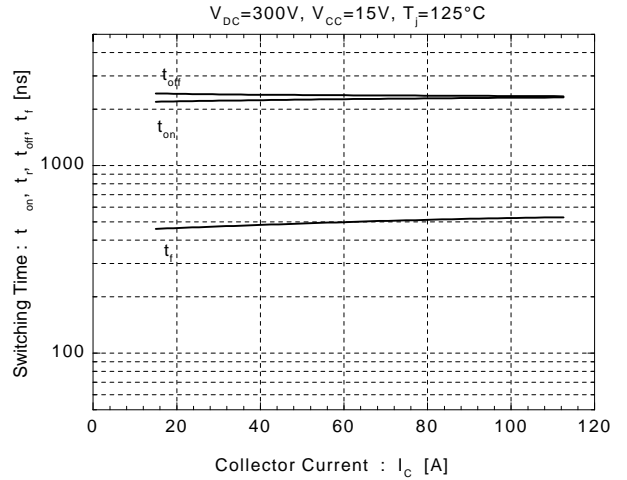

Forward Voltage vs. Forward Current

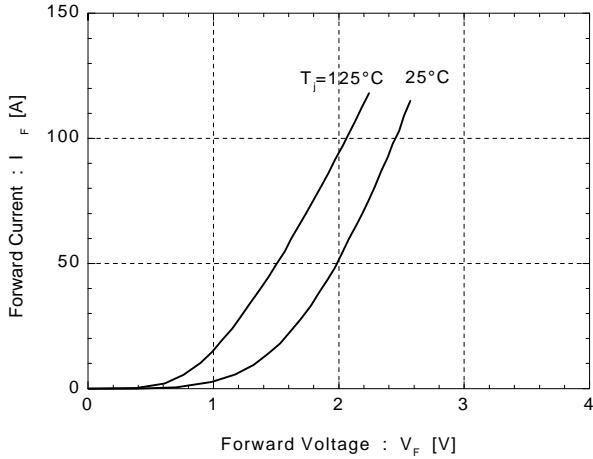

Reverse Recovery Characteristics

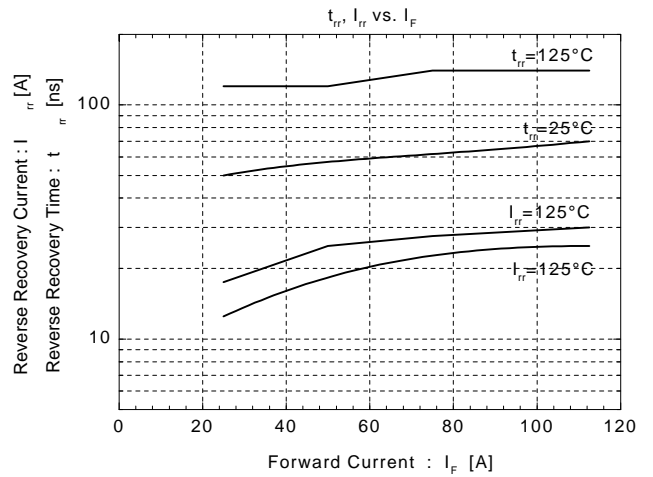

■ Inverter

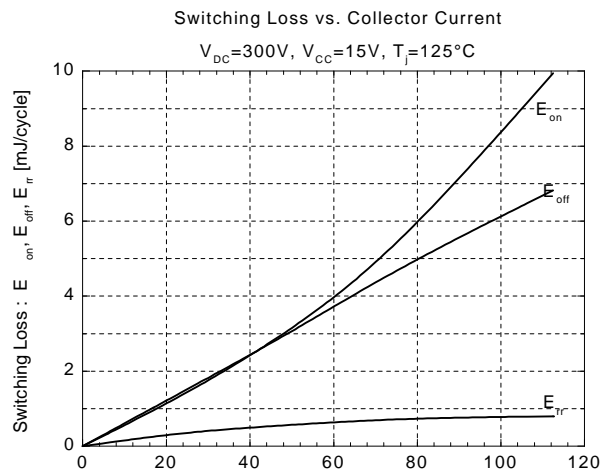
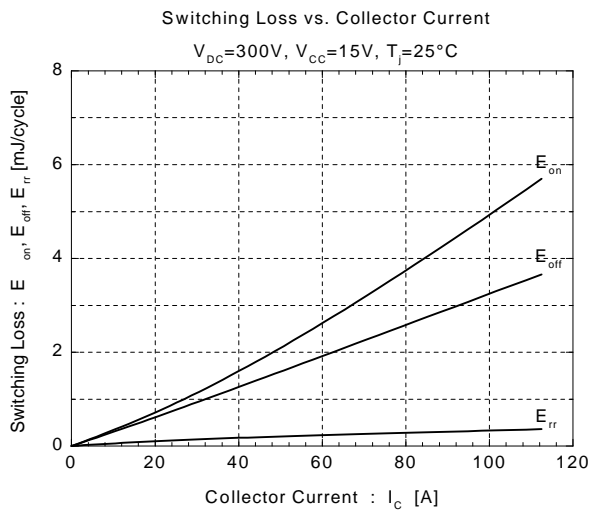
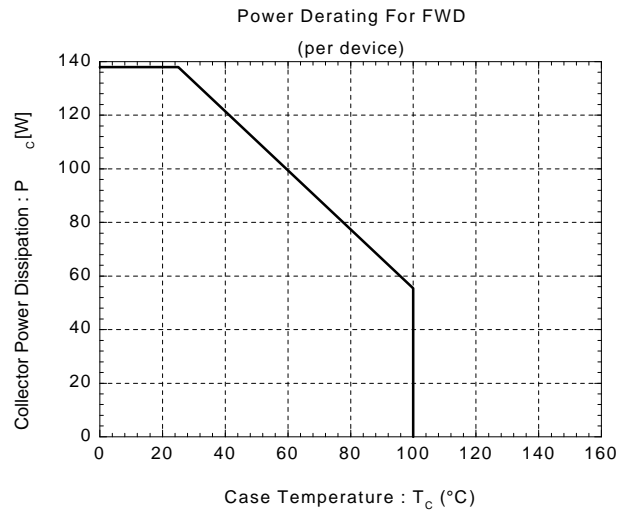
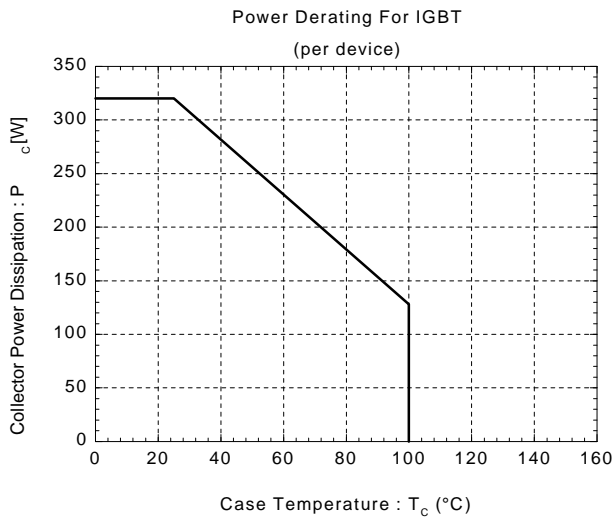
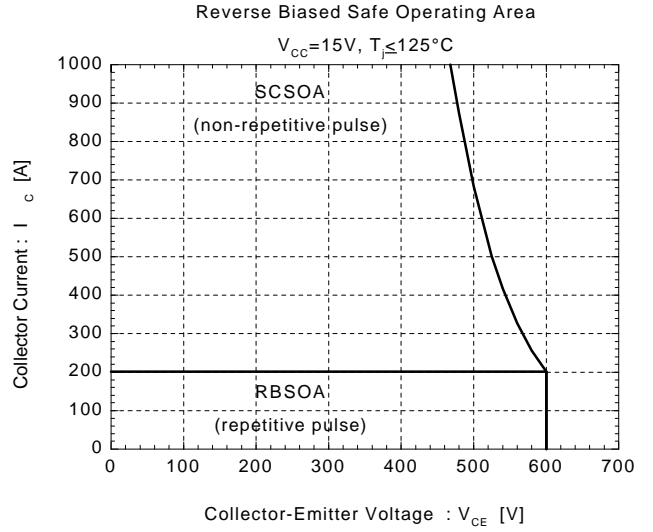
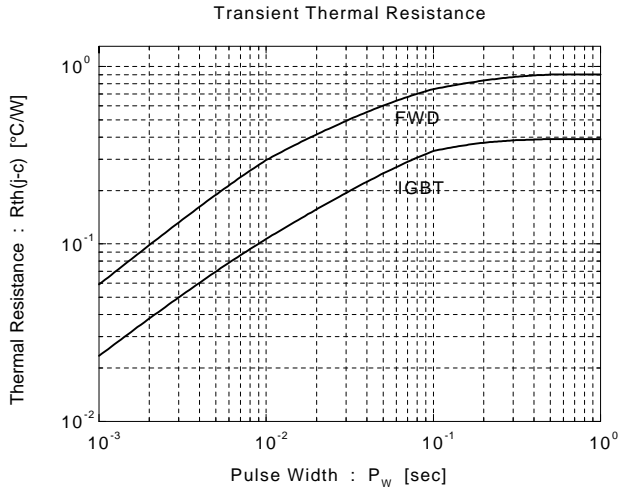

■ Inverter

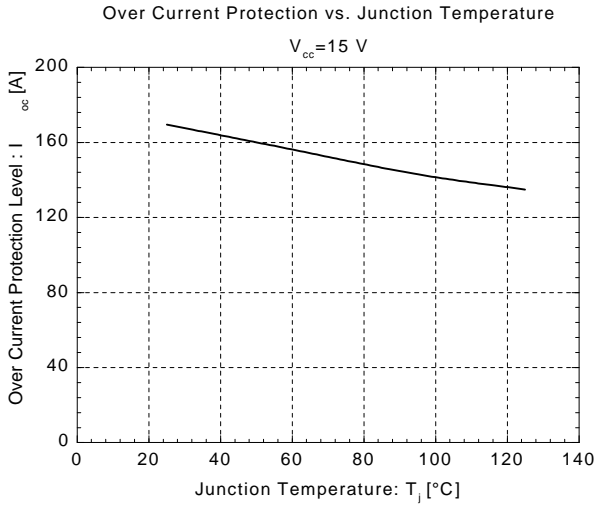

■ Outline Drawing

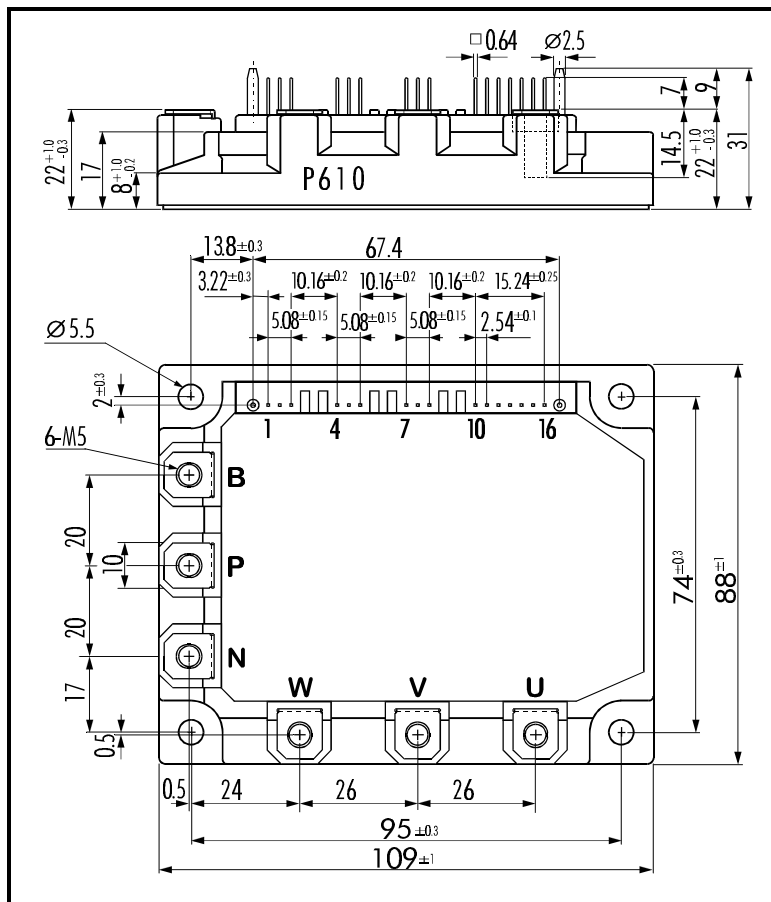

Weight: 440g