

### Super Junction MOSFET

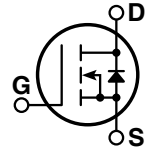

- Ultra low  $R_{DS(ON)}$
- Low Miller Capacitance
- Ultra Low Gate Charge,  $Q_g$
- Avalanche Energy Rated
- TO-247 Package

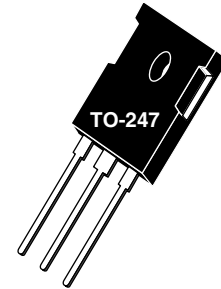

#### MAXIMUM RATINGS

All Ratings:  $T_C = 25^\circ\text{C}$  unless otherwise specified.

| Symbol         | Parameter                                                                                              | APT11N80BC3 | UNIT                |
|----------------|--------------------------------------------------------------------------------------------------------|-------------|---------------------|
| $V_{DSS}$      | Drain-Source Voltage                                                                                   | 800         | Volts               |
| $I_D$          | Continuous Drain Current @ $T_C = 25^\circ\text{C}$                                                    | 11          | Amps                |
| $I_{DM}$       | Pulsed Drain Current <sup>①</sup>                                                                      | 33          |                     |
| $V_{GS}$       | Gate-Source Voltage Continuous                                                                         | $\pm 20$    | Volts               |
| $V_{GSM}$      | Gate-Source Voltage Transient                                                                          | $\pm 30$    |                     |
| $P_D$          | Total Power Dissipation @ $T_C = 25^\circ\text{C}$                                                     | 156         | Watts               |
|                | Linear Derating Factor                                                                                 | 1.25        | W/ $^\circ\text{C}$ |
| $T_J, T_{STG}$ | Operating and Storage Junction Temperature Range                                                       | -55 to 150  | $^\circ\text{C}$    |
| $T_L$          | Lead Temperature: 0.063" from Case for 10 Sec.                                                         | 260         |                     |
| $dv/dt$        | Drain-Source Voltage slope ( $V_{DS} = 640\text{V}$ , $I_D = 11\text{A}$ , $T_J = 125^\circ\text{C}$ ) | 50          | V/ns                |
| $I_{AR}$       | Repetitive Avalanche Current <sup>⑦</sup>                                                              | 11          | Amps                |
| $E_{AR}$       | Repetitive Avalanche Energy <sup>⑦</sup>                                                               | 0.2         | mJ                  |
| $E_{AS}$       | Single Pulse Avalanche Energy <sup>④</sup>                                                             | 470         |                     |

#### STATIC ELECTRICAL CHARACTERISTICS

| Symbol       | Characteristic / Test Conditions                                                                          | MIN | TYP  | MAX       | UNIT          |
|--------------|-----------------------------------------------------------------------------------------------------------|-----|------|-----------|---------------|
| $BV_{DSS}$   | Drain-Source Breakdown Voltage ( $V_{GS} = 0\text{V}$ , $I_D = 250\mu\text{A}$ )                          | 800 |      |           | Volts         |
| $R_{DS(on)}$ | Drain-Source On-State Resistance <sup>②</sup> ( $V_{GS} = 10\text{V}$ , $I_D = 7.1\text{A}$ )             |     | 0.39 | 0.45      | Ohms          |
| $I_{DSS}$    | Zero Gate Voltage Drain Current ( $V_{DS} = V_{DSS}$ , $V_{GS} = 0\text{V}$ )                             |     | 0.5  | 20        | $\mu\text{A}$ |
|              | Zero Gate Voltage Drain Current ( $V_{DS} = V_{DSS}$ , $V_{GS} = 0\text{V}$ , $T_J = 150^\circ\text{C}$ ) |     |      | 200       |               |
| $I_{GSS}$    | Gate-Source Leakage Current ( $V_{GS} = \pm 20\text{V}$ , $V_{DS} = 0\text{V}$ )                          |     |      | $\pm 100$ | nA            |
| $V_{GS(th)}$ | Gate Threshold Voltage ( $V_{DS} = V_{GS}$ , $I_D = 680\mu\text{A}$ )                                     | 2.1 | 3    | 3.9       | Volts         |

 **CAUTION:** These Devices are Sensitive to Electrostatic Discharge. Proper Handling Procedures Should Be Followed.

APT Website - <http://www.advancedpower.com>

"COOLMOS™" comprise a new family of transistors developed by Infineon Technologies AG. "COOLMOS" is a trademark of Infineon Technologies AG"

**DYNAMIC CHARACTERISTICS**

**APT11N80BC3**

| Symbol       | Characteristic               | Test Conditions                                                                                                  | MIN | TYP  | MAX | UNIT    |
|--------------|------------------------------|------------------------------------------------------------------------------------------------------------------|-----|------|-----|---------|
| $C_{iss}$    | Input Capacitance            | $V_{GS} = 0V$<br>$V_{DS} = 25V$<br>$f = 1\text{ MHz}$                                                            |     | 1585 |     | pF      |
| $C_{oss}$    | Output Capacitance           |                                                                                                                  |     | 770  |     |         |
| $C_{rss}$    | Reverse Transfer Capacitance |                                                                                                                  |     | 18   |     |         |
| $Q_g$        | Total Gate Charge ③          | $V_{GS} = 10V$<br>$V_{DD} = 400V$<br>$I_D = 11A @ 25^\circ C$                                                    |     | 60   |     | nC      |
| $Q_{gs}$     | Gate-Source Charge           |                                                                                                                  |     | 8    |     |         |
| $Q_{gd}$     | Gate-Drain ("Miller") Charge |                                                                                                                  |     | 30   |     |         |
| $t_{d(on)}$  | Turn-on Delay Time           | <b>RESISTIVE SWITCHING</b><br>$V_{GS} = 10V$<br>$V_{DD} = 400V$<br>$I_D = 11A @ 25^\circ C$<br>$R_G = 7.5\Omega$ |     | 25   |     | ns      |
| $t_r$        | Rise Time                    |                                                                                                                  |     | 15   |     |         |
| $t_{d(off)}$ | Turn-off Delay Time          |                                                                                                                  |     | 70   | 80  |         |
| $t_f$        | Fall Time                    |                                                                                                                  |     | 7    | 10  |         |
| $E_{on}$     | Turn-on Switching Energy ⑥   | <b>INDUCTIVE SWITCHING @ 25°C</b><br>$V_{DD} = 533V, V_{GS} = 15V$<br>$I_D = 11A, R_G = 5\Omega$                 |     | 165  |     | $\mu J$ |
| $E_{off}$    | Turn-off Switching Energy    |                                                                                                                  |     | 50   |     |         |
| $E_{on}$     | Turn-on Switching Energy ⑥   | <b>INDUCTIVE SWITCHING @ 125°C</b><br>$V_{DD} = 533V, V_{GS} = 15V$<br>$I_D = 11A, R_G = 5\Omega$                |     | 305  |     |         |
| $E_{off}$    | Turn-off Switching Energy    |                                                                                                                  |     | 65   |     |         |

**SOURCE-DRAIN DIODE RATINGS AND CHARACTERISTICS**

| Symbol   | Characteristic / Test Conditions                                           | MIN | TYP | MAX | UNIT    |
|----------|----------------------------------------------------------------------------|-----|-----|-----|---------|
| $I_S$    | Continuous Source Current (Body Diode)                                     |     |     | 11  | Amps    |
| $I_{SM}$ | Pulsed Source Current ① (Body Diode)                                       |     |     | 33  | Amps    |
| $V_{SD}$ | Diode Forward Voltage ② ( $V_{GS} = 0V, I_S = -11A$ )                      |     | 1   | 1.2 | Volts   |
| $t_{rr}$ | Reverse Recovery Time ( $I_S = 11A, di_S/dt = -100A/\mu s, V_R = 640V$ )   |     | 550 |     | ns      |
| $Q_{rr}$ | Reverse Recovery Charge ( $I_S = 11A, di_S/dt = -100A/\mu s, V_R = 640V$ ) |     | 10  |     | $\mu C$ |
| $dv/dt$  | Peak Diode Recovery $dv/dt$ ⑤                                              |     |     | 6   | V/ns    |

**THERMAL CHARACTERISTICS**

| Symbol          | Characteristic      | MIN | TYP | MAX  | UNIT         |
|-----------------|---------------------|-----|-----|------|--------------|
| $R_{\theta JC}$ | Junction to Case    |     |     | 0.80 | $^\circ C/W$ |
| $R_{\theta JA}$ | Junction to Ambient |     |     | 62   |              |

① Repetitive avalanche causes additional power losses that can be calculated as  $P_{AV} = E_{AR} * f$

② Pulse Test: Pulse width < 380  $\mu s$ , Duty Cycle < 2%

③ See MIL-STD-750 Method 3471

④ Starting  $T_j = +25^\circ C, L = 194mH, R_G = 25\Omega, \text{Peak } I_L = 2.2A$

⑤  $dv/dt$  numbers reflect the limitations of the test circuit rather than the device itself.  $I_S \leq -I_D 11A, di/dt \leq 700A/\mu s, V_R \leq V_{DSS}, T_j \leq 150^\circ C$

⑥  $E_{on}$  includes diode reverse recovery. See figures 18, 20.

⑦ Repetitive avalanche causes additional power losses that can be calculated as  $P_{AV} = E_{AR} * f$

APT Reserves the right to change, without notice, the specifications and information contained herein.

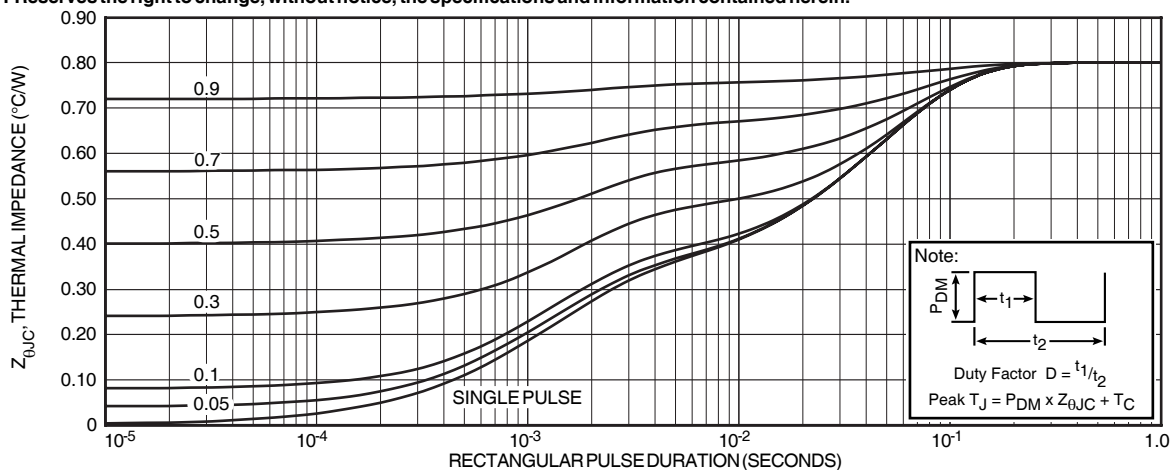

FIGURE 1, MAXIMUM EFFECTIVE TRANSIENT THERMAL IMPEDANCE, JUNCTION-TO-CASE vs PULSE DURATION

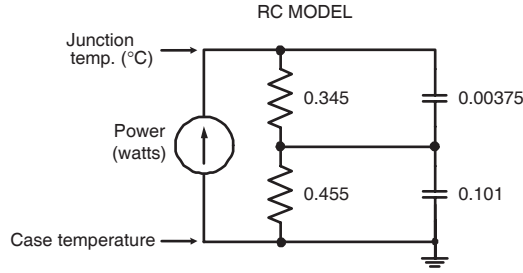

FIGURE 2, TRANSIENT THERMAL IMPEDANCE MODEL

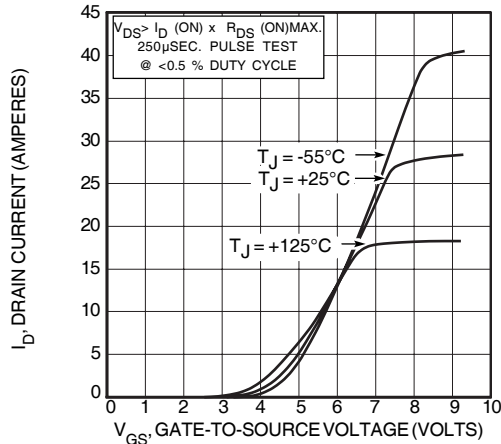

FIGURE 4, TRANSFER CHARACTERISTICS

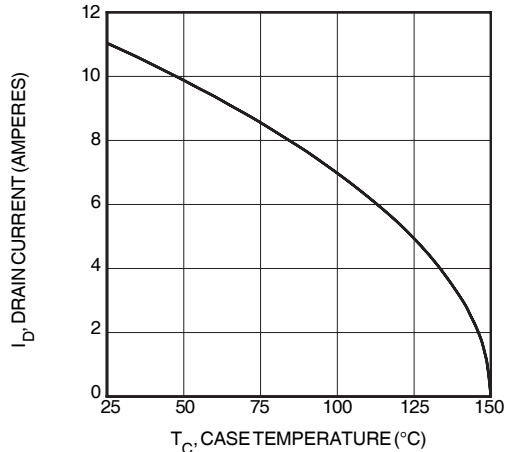

FIGURE 6, MAXIMUM DRAIN CURRENT vs CASE TEMPERATURE

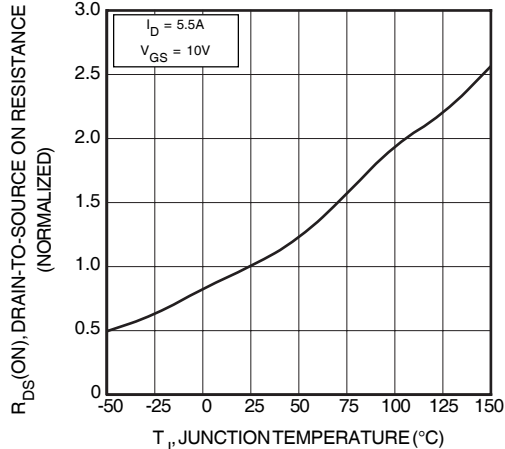

FIGURE 8, ON-RESISTANCE vs. TEMPERATURE

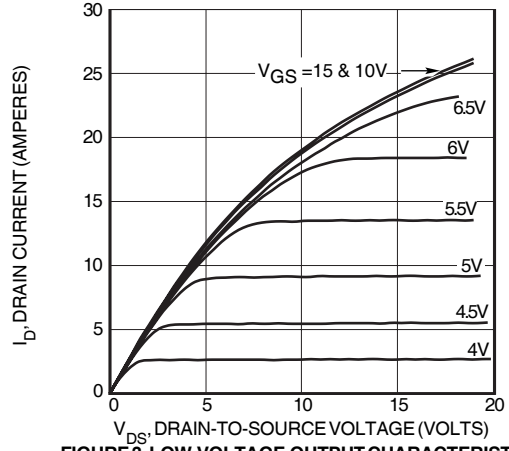

FIGURE 3, LOW VOLTAGE OUTPUT CHARACTERISTICS

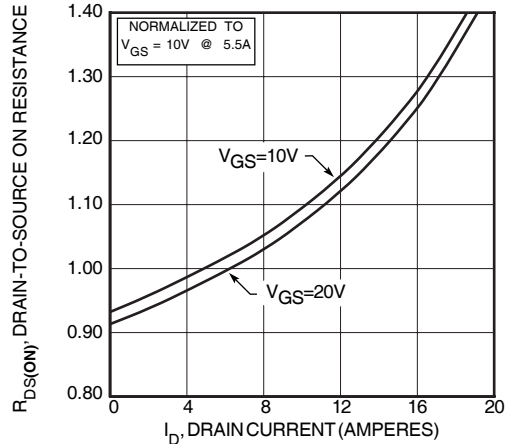

FIGURE 5,  $R_{DS(ON)}$  vs DRAIN CURRENT

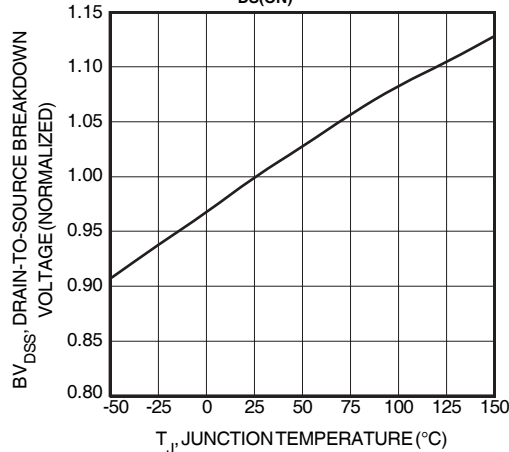

FIGURE 7, BREAKDOWN VOLTAGE vs TEMPERATURE

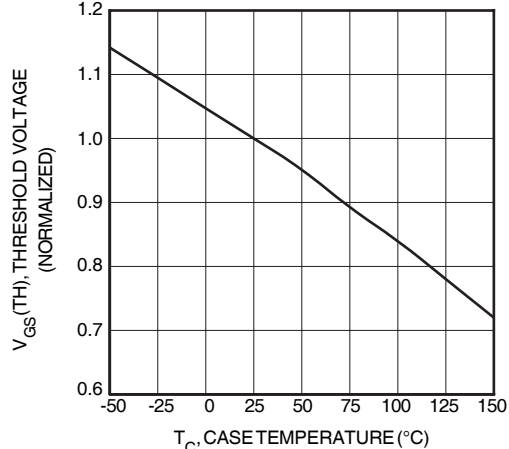

FIGURE 9, THRESHOLD VOLTAGE vs TEMPERATURE

# Typical Performance Curves

APT11N80BC3

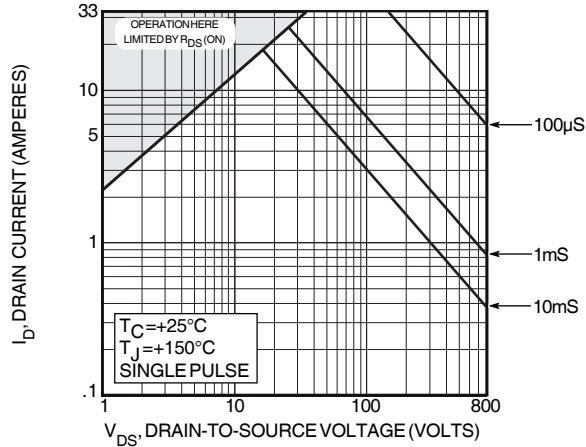

FIGURE 10, MAXIMUM SAFE OPERATING AREA

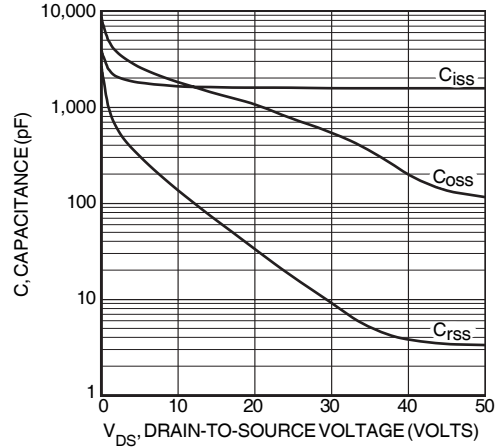

FIGURE 11, CAPACITANCE vs DRAIN-TO-SOURCE VOLTAGE

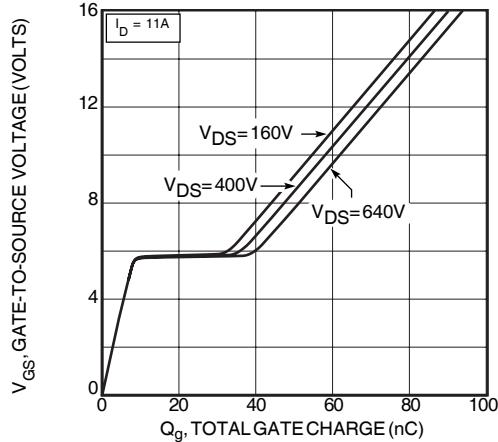

FIGURE 12, GATE CHARGES vs GATE-TO-SOURCE VOLTAGE

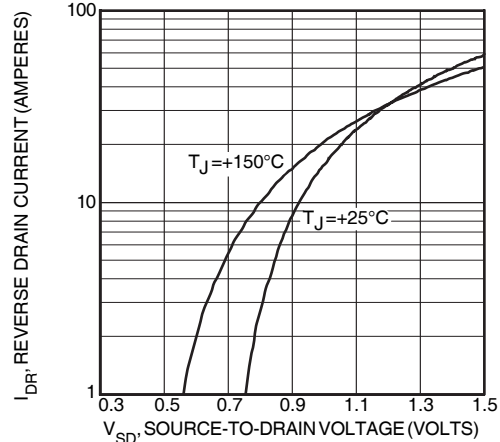

FIGURE 13, SOURCE-DRAIN DIODE FORWARD VOLTAGE

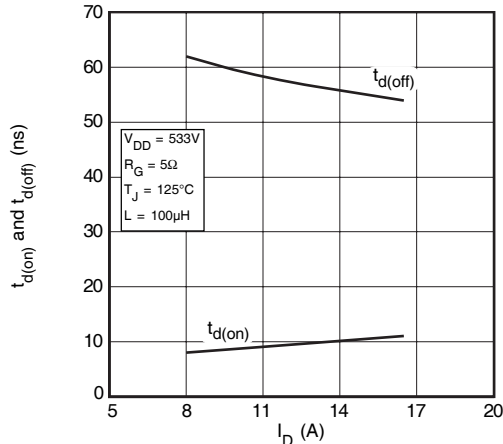

FIGURE 14, DELAY TIMES vs CURRENT

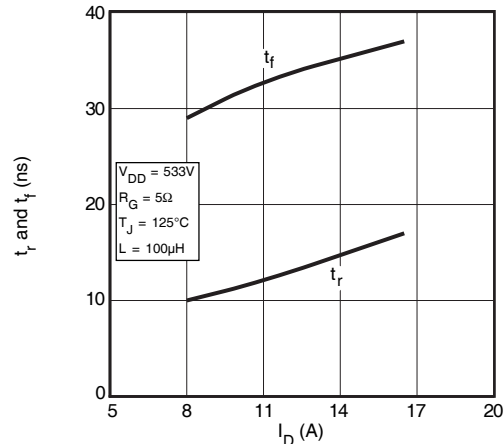

FIGURE 15, RISE AND FALL TIMES vs CURRENT

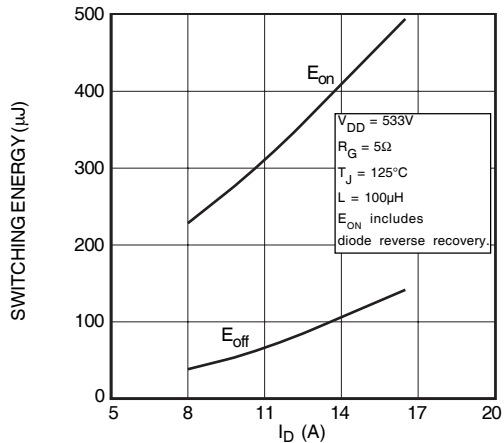

FIGURE 16, SWITCHING ENERGY vs CURRENT

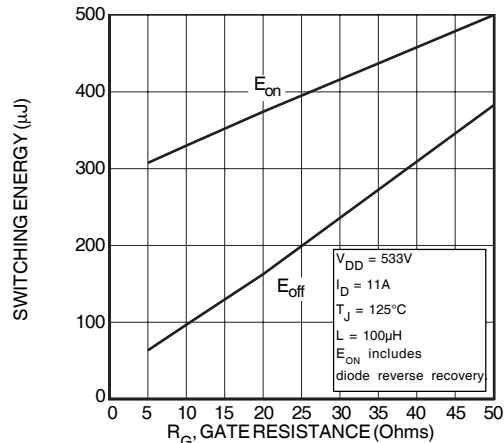

FIGURE 17, SWITCHING ENERGY vs. GATE RESISTANCE

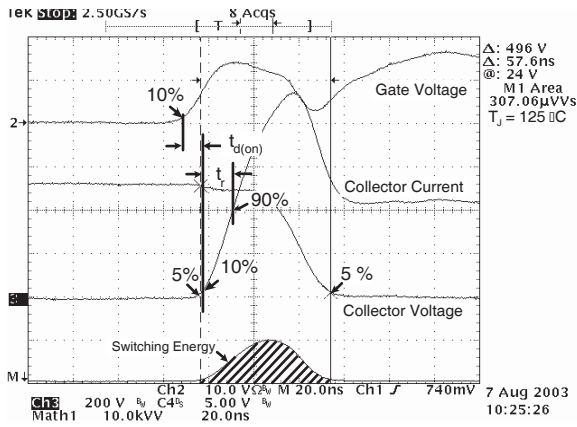

Figure 18, Turn-on Switching Waveforms and Definitions

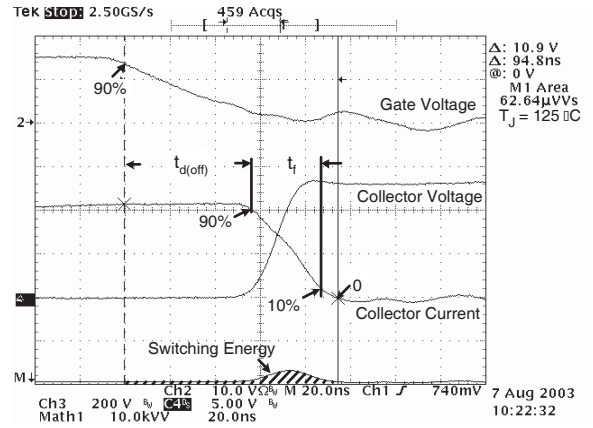

Figure 19, Turn-off Switching Waveforms and Definitions

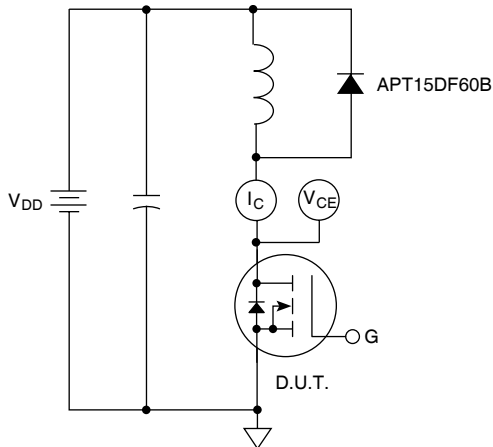
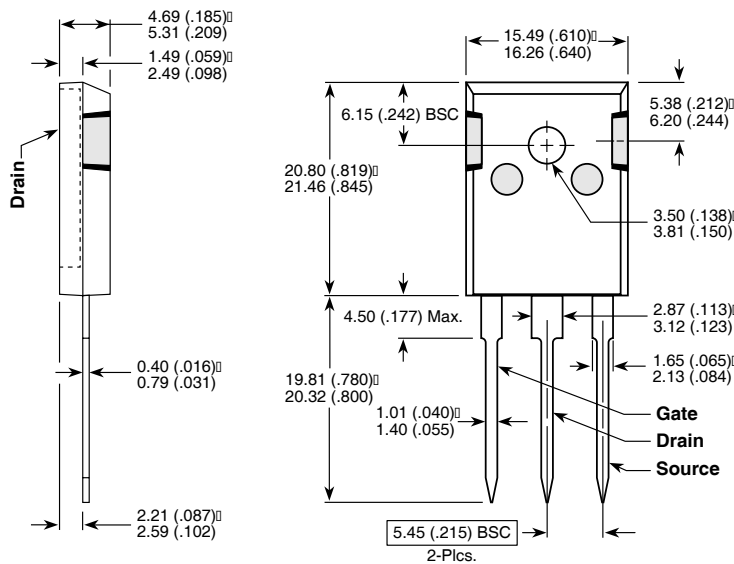

Figure 20, Inductive Switching Test Circuit

TO-247 Package Outline



Dimensions in Millimeters and (Inches)

APT's products are covered by one or more of U.S. patents 4,895,810 5,045,903 5,089,434 5,182,234 5,019,522 5,262,336 6,503,786 5,256,583 4,748,103 5,283,202 5,231,474 5,434,095 5,528,058 and foreign patents. US and Foreign patents pending. All Rights Reserved.